Flooring Installation and Care Instructions

MEISTER

MEISTER Flooring Installation and Care Instructions

Contents

Laying instructions	6
Preparatory measures, substrates and general information	6
Laying instructions for Longlife parquet and Lindura wood flooring	8
Longlife parquet and Lindura wood flooring with Mastercllic Plus technology	8
Longlife parquet Style PQ 500 with Quadrolic Plus technology	10
Longlife parquet Residence PS 500 with Quadrolic Plus technology	12
Longlife parquet Residence PS 400 with Uniclic technology	14
Longlife Parquet Penta PD 550 with longitudinal Uniclic technology	16
Laying instructions for longlife parquet and Lindura wood flooring on walls	18
Longlife parquet Penta PD 450, Cottage PD 400, Residence PS 300, Style PC 400, Classic PC 200, Classic PD 200, Classic PD 150 and Lindura wood flooring HD 300 with Mastercllic Plus technology	18
Laying instructions for cork, linoleum, design, Nadura and laminate flooring	20
Cork, linoleum, design, Nadura and laminate flooring with Mastercllic Plus technology	20
Laminate flooring with Multiclic technology	22
Design flooring with Multiclic technology	23
Nadura flooring NQ 500 with Quadrolic Plus technology	24
Laying instructions for laminate flooring in humid rooms	26
Laminate flooring Melango, Micala and Talamo	26
Mouldings and accessories	28
Flooring profiles	28
Wall transitions mouldings	30
Underlay material	31
Installation on warm water underfloor heating structures	32
Longlife parquet	32
Lindura wood flooring	33
Cork flooring	34
Linoleum flooring	35
Design flooring	36
Nadura flooring	37
Laminate flooring	38
Full surface bonding	39
Cleaning and care instructions	40
Warranty conditions	46

Quality starts with
the installation.



You have purchased quality »Made in Germany«. For us, MEISTER quality is not just about the durability of your floor. It can also be seen during the installation of your floor. We rely on a middle layer of extremely stable HDF or special wood materials for all our flooring types. And we use click systems, which are tailored to the properties of the flooring and dimensions of the planks, together with the patented Masterclac Plus or Quadroclac

Plus system, which was developed within our own company, and the tried-and-tested Uniclic connection system. This ensures optimal precision of fitting that you can feel while installing your new flooring. MEISTER flooring is especially easy to install. That's why many craftsmen swear by products from MEISTER. You will find a lot of information about how to work with your MEISTER product in these installation and care instructions.



Preparatory measures, substrates and general instructions

Preparatory measures

The packages must be acclimatised before you open them. Store them unopened and lying flat on the ground for approx. 48 hours (in winter 3–4 days) in the centre of the room you want to work in.

Do not store the packages in front of damp or freshly-wallpapered walls. Before you install the flooring, outer doors and windows must be installed and all painting and decorating work must be finished. The room temperature must be approx. 20°C (at least 15°C), and the relative humidity must be approx. 30–65 percent.

The flooring requires a permanent living climate of approx. 30–65 percent relative humidity at a room temperature of 18–22°C. If you measure or anticipate a significantly lower humidity, you must install a humidifier (vapouriser) to prevent the flooring from drying out excessively.

Parquet, Lindura wood flooring, cork, linoleum and Nadura flooring are natural products. Variations are an indication of its natural and genuine quality. Bleaching may occur with all flooring with direct sunlight or intense, artificial lighting. As a natural product, wood has hygroscopic properties. Dry cracks can appear as the wood expands/contracts, and are not due to faulty quality. In contrast to standard parquet floors our longlife parquet in a planked look has deliberately been produced at the factory with open joints and slits that underlines the special character property. Mix planks from several packs so that, before laying, you achieve the floor pattern you want. Before installation, check all planks in daylight for recognisable faults in colour and structure. You cannot make a claim for any products you have already installed.

Important information about linoleum flooring

Drying oven film: Linoleum is a product made from natural raw materials. It obtains the right proportional balance of elasticity and toughness in the drying oven. During the drying process, a light yellow film forms on the surface of the material - this is called the drying oven film. This film disappears under UV radiation (sunlight). How long that takes depends on the intensity of the sunlight. The flooring only develops its true colour after the film has disappeared. This effect is unavoidable and an indicator of the natural substances used. Please note that the effect is more noticeable on light colours than on darker surfaces.

Please be aware that our Silence »S« flooring collections already have the sound-absorbing underlay integrated into them.

Substrates

The substrates must be considered as ready-to-lay in accordance with the generally accepted rules of the trade, taking into account VOB (German Construction Contract Procedures), Part C, DIN 18 356 »Parquetry« or DIN 18 365 »Floorcovering work« respectively. In other words, they must be dry, even, firm and clean. The residual humidity, measured using the CM method, of mineral substrates must be no more than 2 percent (1.8 percent for underfloor heating) and that of anhydrite screeds must be a maximum of 0.5 percent (0.3 percent for underfloor heating). Any substrate unevenness of three or more millimetres for each initial metre and two or more millimetres for each subsequent continuous metre must be evened out according to DIN 18 202, Table 3, line 4. 0.2 millimetre thick PE film (SD value $\geq 75\text{m}$) must be laid out on all mineral substrates (except poured asphalt screed) as a vapour barrier. The strip edges must overlap by at least 20 centimetres and the overlapping edges must be glued to the side walls.

In rooms that are not above a cellar and foundations, the currently valid building conditions require that the owner of the building provide a barrier against damage to the base plate due to moisture from the ground, in accordance with the DIN 18 195 directive.

MEISTER flooring can be laid on existing surfaces, such as PVC, linoleum or stone, so long as the old flooring is firmly bonded and there are no loose areas. In addition, a separating layer of foil should be applied to the substrate. On existing wooden planks, wood-based boards, OSB-boards, drywall elements etc., no vapour barrier must be used. Textile flooring such as, e.g. carpet or needle fleece must be removed not only for technical reasons, but for hygiene reasons too.

General instructions

MEISTER flooring (except for laminate flooring Melango, Micala and Talamo - see page 26) is not suitable for installation in humid rooms/wet areas (bathrooms, saunas, swimming pool etc.).

The floor is installed as a floating floor, without glue. The Masterclit Plus connection system makes it possible to install the flooring quickly and easily. The end interlocking occurs when the next row is laid. In addition, it is a valuable installation aid, as the planks can be aligned against each other in this way. To do this, you should lift the plank slightly and square it quite easily with the tongue in the groove of the plank which has already been laid.

If the floor area is longer or wider than 10m then you must provide an expansion joint. This is covered with a jointing profile. It is also important to provide these joints between two adjacent rooms, in doorways, passageways and rooms with a lot of angles. Always use a jointing profile for clean transitions to adjacent, lower areas or floor coverings and an end profile next to higher adjacent thresholds, tiles or the like. Give stairs a clean finish with the stair edge profile.

During installation, take care to leave a gap of at least 10 or 1.5 millimetres per metre (15 millimetres for parquet flooring and Lindura wood flooring) next to all walls. This distance must also be left around all columns, heating pipes, steel door frames, etc. It may be possible to shorten wooden door frames. To do this, lay a loose plank with the decorative side down against the door frame and saw the frame off along the plank.

To protect the wood from dirt, a sufficiently large entrance covering must always be laid (e.g. a doormat, carpet). In addition, you should also fit chair and furniture feet with felt sliders; office chairs, mobile containers, etc., on castors must be equipped with soft, standard running surfaces. Coloured rubber, natural rubber or plastic glides and castors as well as dark car, bike or equipment tyres may possibly cause discolouration on design flooring. Please only use light, non-migrating furniture glides, castors or tyres, if possible. We recommend protecting the floor in these heavy-wear areas with appropriate floor protection mats (e.g. polycarbonate mats).

MEISTER Nadura floors have an extremely durable and highly wear-resistant surface. Visible signs of wear or shiny/glossy areas are characteristic of hard wood flooring, depending on wear.

We recommend that you install the planks lengthways to the way the light falls. In narrow or long rooms, choose the laying direction to suit the room's proportions. Lay the planks crossways to make narrow rooms look more spacious; planks laid lengthways narrow hallways.

Please first check whether a subfloor is required as explained in "Substrates". Furthermore, if you are using products without a sound-absorbing Silence cushion, use the system-bound MEISTER insulating underlay. (If you use MEISTER-Silence 25 DB, MEISTER-Silence 15 DB, or MEISTER Duo-Guard, you do not need an additional layer of 0.2-millimetre PE film). **Other insulating underlay needs to have a corresponding compressive strength (CS value $\geq 15\text{kPa}$, $\geq 60\text{kPa}$ in commercial areas with heavy wear) and a thickness of 1 - 3mm. For MEISTER design flooring Catega® Flex DD 300 as well as Classic design flooring (DC 75, DD 75 and DD 85), a compressive strength of $\geq 60\text{kPa}$ is generally required.**

When sawing the elements, make sure you work from the correct side: if you use a bench saw, keep the wear layer side facing up if you use a keyhole or portable circular saw, keep the wear layer side down.

For laying Lindura wood flooring and Nadura floors hard metal saw blades or diamond tipped saw blades are required.

MEISTER Longlife parquet and Lindura wood flooring with Mastercllic Plus technology

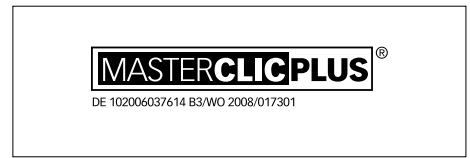

You need the following tools and aids to install MEISTER Longlife parquet and Lindura wood flooring with Mastercllic Plus technology.

Keyhole or electric saw (for Lindura wood flooring hard metal saw blades or diamond tipped saw blades), possibly power drill, folding metre rule, pencil, wedges (spacer wedges), angle or adjustable bevel, possibly PE film (0.2 millimetres).

Use MEISTER foam film, MEISTER-Silence 15 DB, MEISTER-Silence 20, MEISTER-Silence 25 DB, or MEISTER Duo-Guard as a cushioning layer. (When using MEISTER-Silence 25 DB, MEISTER-Silence 15 DB or MEISTER-Duo-Guard, additional 0.2 millimetre PE film is not required.)

Step 1

Start by laying the first complete plank in the left-hand corner of the room with the tongue sides facing the wall. Remove only the tongues on the long sides of all the other planks you want to lay in the first row (fig. 1). Using wedges, you can easily keep a gap of at least 15 millimetres from the wall.

Step 2

Insert the end of the next complete plank into plank No. 1 (fig. 2). Lay the other planks in this row in the same way across the entire width of the room.

Step 3

Cut the last plank in each row so that you leave a gap of at least 15 millimetres to the wall (fig. 3). You can use cut-off pieces of planks, as long as they are at least 40 centimetres long, to start subsequent rows.

Step 4

Make sure the planks in the first row are straight. Cut the first plank in the second row to approx. 80 centimetres (PD 150 approx. 30 centimetres). Fix this plank upright with the spring as far as possible into the groove on the groove side of the previous row of planks and press the plank down slowly, using a forward and downward turning motion (fig. 4). The plank should lock into the previously laid row (fig. 5).

Step 5

Similarly, the next complete plank is turned into the click connection on the long side and the end pushed tight against the previous plank before it is lowered. Then press the plank down slowly, using a forward and downward turning motion (fig. 6). The plank must lock into the row previously laid and the end joint must fit tightly into the previous plank.

Step 6

Lay the flooring row by row in this way. Remember that the end joints must be offset by at least 40 centimetres (PD 150 approx. 30 centimetres) (fig. 7).

Step 7

To cut the last row to size, use a spare piece of plank and draw the remaining plank width on it (leaving at least a 15-millimetre gap to the wall).

Step 8

Taking the plank marked for width, push the plastic end tongue forward out of the end groove with the aid of a spare piece of plank (fig. 8).

Step 9

Begin cutting the plank to size at the end of the plastic tongue (fig. 9). After the plank has been cut to size, push the plastic tongue on the end back into the end groove (fig. 10).

Step 10

Begin laying the last row in the right hand corner of the room (leaving at least a 15mm gap to the wall) and angle the sides of the plank into the second-last row. The next plank is pivoted in in the same way and lowered down at the end (fig. 11).

Step 11

Push the plastic tongue which is pointing out towards the wall (fig. 12) back into the end connection using a tension rod, scraper, screw driver or similar (fig. 13).

Step 12

Before attaching the skirting boards, the timber wedges along the walls have to be removed.

To cover the all-round expansion joints, use MEISTER real wood veneered skirting boards (see page 30).

Please ensure that no silicon products whatsoever come into contact with the mouldings.

To take a plank row back out again, lift the entire row, levering it at the side out of the last row (fig. 14). Then you can separate the planks' ends by angling them (fig. 15). Should you wish to reuse the disassembled planks, you should push the end plastic spring tongue back into the top groove.

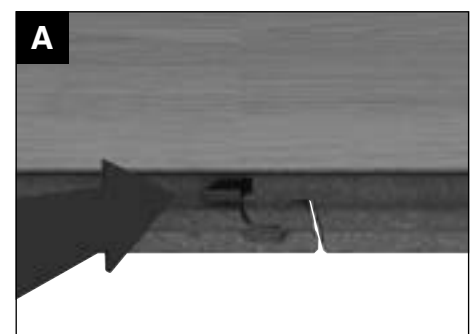
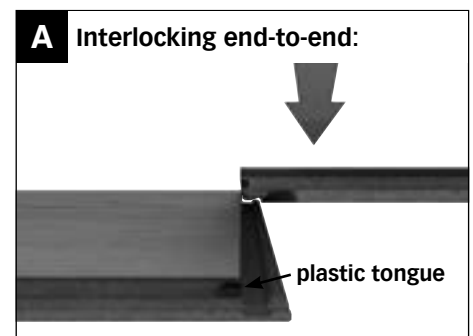
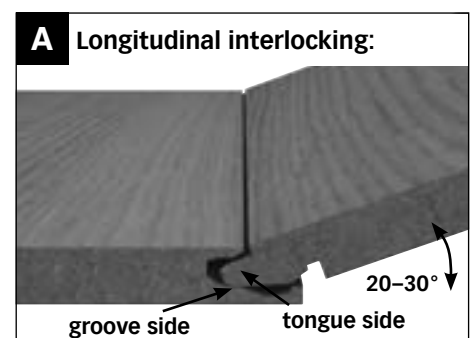

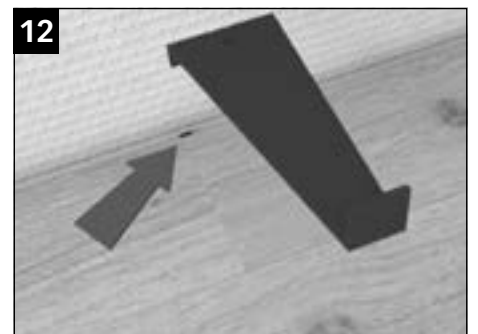
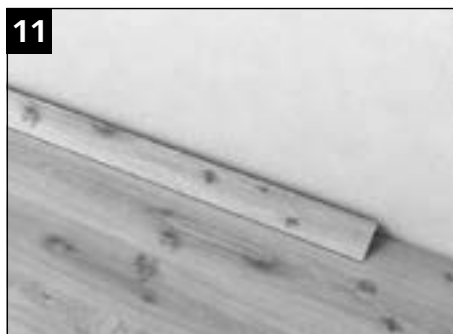
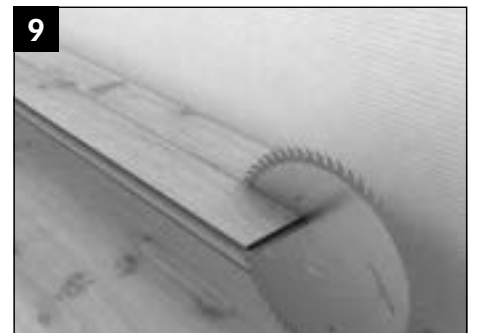
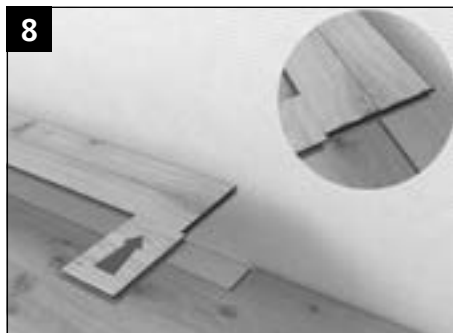
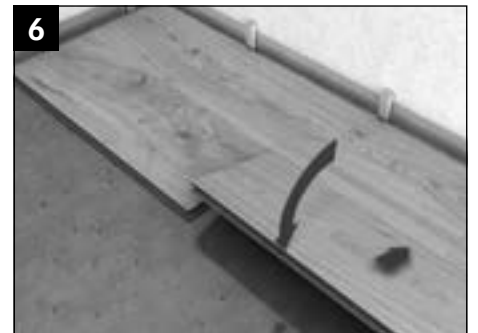
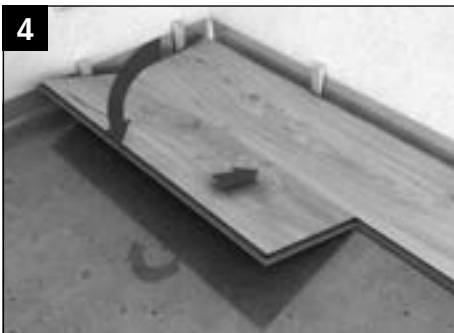

MEISTER Longlife parquet Style PQ 500 with Quadroclit Plus technology

QUADROCLITPLUS®

You need the following tools and aids to install MEISTER Longlife parquet PQ 500 with Quadroclit Plus technology:

Hammer, keyhole or electric saw, possibly power drill, folding metre rule, pencil, wedges (spacer wedges), Quadroclit tapping block, tension iron, angle or adjustable bevel, possibly PE film (0.2 millimetres).

Use MEISTER foam film, MEISTER-Silence 15 DB, MEISTER-Silence 20, MEISTER-Silence 25 DB or MEISTER Duo-Guard as a cushioning layer. (If you use MEISTER Silence 25 DB, MEISTER-Silence 15 DB or MEISTER Duo-Guard, you do not need an additional layer of 0.2-millimetre PE film.)

General instructions

The Quadroclit Plus click connection (fold down system) allows you to work quickly and safely. This product's square shape is ideal for installation in chessboard format. It is also possible to install it in different laying patterns. Generally the squares are angled in (fig. I) and lowered (fig. II) and instantly locked by applying pressure from above. The squares can be angled in and pivoted out. In addition, it may be necessary to tap them together using the matching "Quadroclit" tapping block, e.g. in specific installation situations such as in the area around door frames etc. It may also be required to remove the plastic tongue here. If you want to reuse the disassembled planks, you have to manually reinsert the plastic tongue into the middle of the groove again (fig. III).

Step 1

There are 2 squares each labelled type A and type B on the back (fig. IV) in every packet. Start by installing the first complete type A square in the left-hand corner of the room with the tongues facing the wall (plastic tongue facing the left-hand wall) (fig. 1). Using the wedges you can easily maintain a gap of at least 15 millimetres to the wall.

Step 2

Angle the next complete type B square into the first square with the plastic tongue facing the wall and slowly press it down using a forwards and downwards movement (fig. 2). It locks into the click connection. Install the entire row in the same way, alternating between type A and type B squares (fig. 3).

Step 3

The last planks in each row are cut to size so that a gap of 15 millimetres to the wall is taken into account. If you want a symmetrical installation pattern, you have to join the rows accordingly.

Step 4

Make sure that the squares in the first row are straight. Start the second row with a type B square and insert it into the previous square with the plastic tongue (fig. 4).

Step 5

The next complete type A square is angled into the first row with the tongue and lowered into the previous square with the plastic tongue side (fig. 5).

The whole room is installed by angling the new squares to be installed into the previous row and simply lowering into the square to the left, applying slight pressure from above if necessary (hand or hammer, do not damage the surface).

Step 6

To cut the last row to size use a spare piece of a plank and draw the remaining plank width on it (leaving a gap of at least 15 mm to the wall).

Step 7

You have to remove the wooden wedges along the walls before attaching the skirting boards. Use the MEISTER real wood veneered skirting boards to cover the all-round expansion joints (see page 30).

To disassemble the flooring you have to twist the whole row out of the profile from above. You can then pivot the squares out. The lock-

ing mechanism remains intact as a result, although the plastic tongue has to be manually pressed into the middle of the groove again (fig. III).

For installation without a chessboard format please always install type A squares (from left to right) and type B squares (always from right to left) in rows. As a result the plastic tongue is always facing the element that has already been installed and automatically clicks in when lowered.

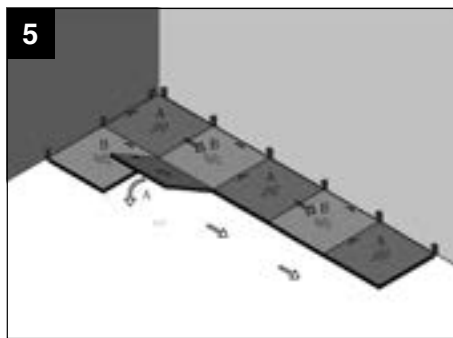
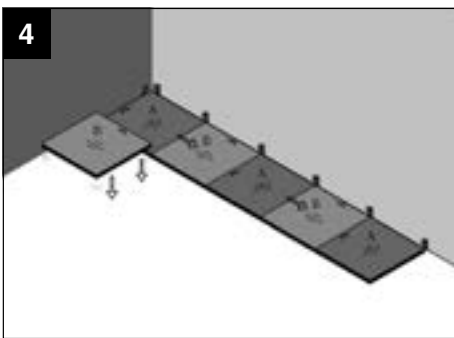
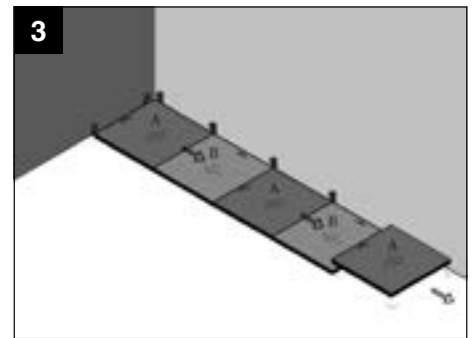
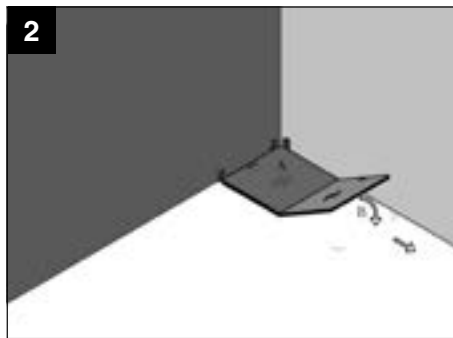
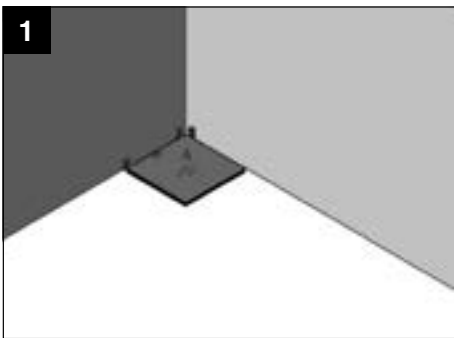
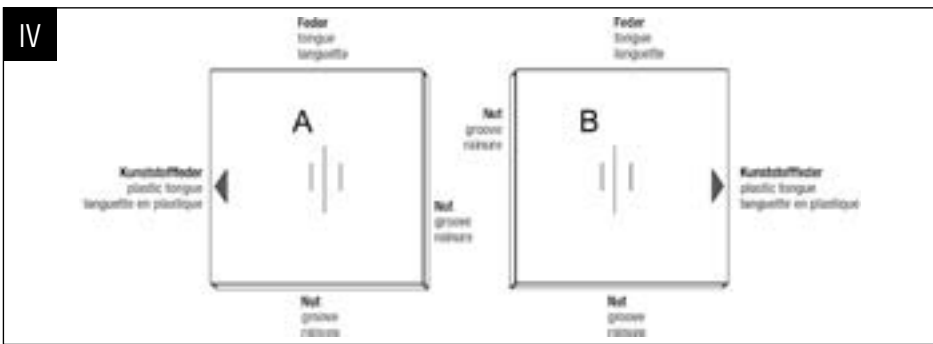
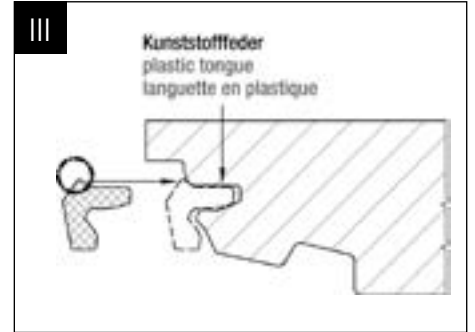
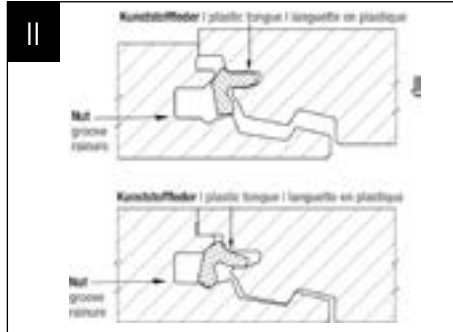
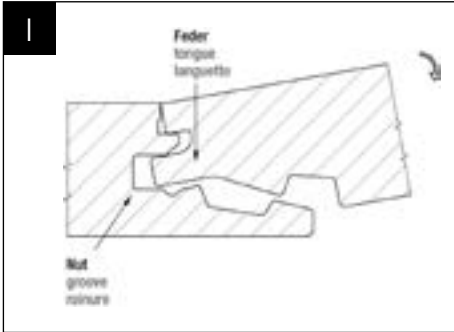

MEISTER Longlife parquet Residence PS 500 with Quadroclit Plus technology

QUADROCLITPLUS®

You need the following tools and aids to install MEISTER Longlife parquet flooring PS 500 with Quadroclit Plus technology:

MEISTER herringbone template, hammer, keyhole or electric saw, possibly power drill, folding metre rule, pencil, MEISTER "Quadroclit" tapping block, wedges (spacer wedges), tension rod, angle or adjustable bevel, possibly PE film (0.2 millimetres). Use the MEISTER Silence 15 DB, MEISTER Silence 20 or MEISTER Silence 25 DB as an insulating underlay to absorb footfall noise (when using MEISTER Silence 25 DB or MEISTER Silence 15 DB an additional 0.2 millimetre PE film is not required).

General information

The Quadroclit Plus click connection (fold down system) allows you to work quickly and safely and produce different laying patterns, e.g. an irregular lattice, regular lattice, herringbone look or even square, ladder or braid pattern. Generally the longitudinal sides are angled in (fig. I) and the ends are lowered (fig. II) and instantly locked by applying pressure from above. The planks can be angled in and pivoted out both longitudinally and at the ends. In addition, it may be necessary to tap both the end and longitudinal joints together using the matching "Quadroclit" tapping block, e.g. in specific installation situations such as in the area around door frames etc. It may also be required to remove the plastic tongue here. If you want to reuse the disassembled planks, you have to manually reinsert the plastic tongue into the middle of the groove again (fig. III).

There are 4 planks each labelled type A and type B on the back (fig. IV) in every packet.

Installing a parallel herringbone lattice

If you want a symmetrical installation pattern, you have to join the rows accordingly.

Step 1

Start the installation in the left-hand corner of the room using the planks labelled type A. The plastic tongues must be facing the left-hand wall. In the first row the type A planks are joined longitudinally with an offset end of exactly 142 mm. You can also use the MEISTER herringbone template for the precise offset (fig. 1).

Step 2

Please note, the first row has to be completely cut to size and installed first. Using the wedges you can easily maintain a gap of at least 15 millimetres to the wall (fig. 2). The leftover pieces of planks there can possibly be used at the start of the next herringbone. Mark the leftover pieces A or B accordingly on the back.

Step 3

The second row is then installed using the type B planks. Each plank is angled-in longitudinally and lowered at the end (fig. 2). The plastic tongue clicks in when a bit of pressure is applied from above.

Step 4

Install the entire area up to the end of the room in this order (fig. 3). The planks that end at the wall are cut to size so that a gap of 15 millimetres to the wall is taken into account. When installing in a different direction or with specific room situations, the longitudinal sides and ends can be tapped together using the "Quadroclit" tapping block. When tapping the plastic tongues flat into the appropriate grooves, the element has to be clicked in again by applying pressure or tapping from above, once the end joint is closed.

Step 5

You have to remove the wooden wedges along the walls before attaching the skirting boards. Use the MEISTER real wood veneered skirting boards to cover the all-round expansion joints. Please avoid any silicon products coming into contact with the skirting boards.

Diagonal herringbone lattice

If you want a symmetrical installation pattern, you have to join the rows accordingly.

Step 1

Start the installation using the planks labelled type A. The longitudinal tongues must be facing the wall. In the first row the type A planks are joined longitudinally with offsetting of the end joints of exactly 142mm. You can also use the MEISTER herringbone template for the precise offset (fig. 1).

Step 2

Please note, the first row has to be completely cut to size and installed first. Using the wedges you can easily maintain a gap of at least 15 millimetres to the wall (fig. 1).

Step 3

The second row is then installed using the type B planks. Each plank is angled-in longitudinally and lowered at the end (fig. 2). The plastic tongue clicks in when a bit of pressure is applied from above.

Step 4

Install the entire area up to the end of the room in this order (fig. 3). The planks that end at the wall are cut to size so that a gap of 15 millimetres to the wall is taken into account. The leftover pieces of planks there can possibly be used at the start of the next herringbone. Mark the off-cut pieces A or B accordingly on the back. When installing in a different direction or with specific room situations, the longitudinal sides and ends can be tapped together using the "Quadroclit" tapping block. When tapping the plastic tongues flat into the appropriate grooves, the element has to be clicked in again by applying pressure or tapping from above, once the end joint is closed.

Step 5

You have to remove the wooden wedges along the walls before attaching the skirting boards. Use the MEISTER real wood veneered skirting boards to cover the all-round expansion joints. Please avoid any silicon products coming into contact with the skirting boards.

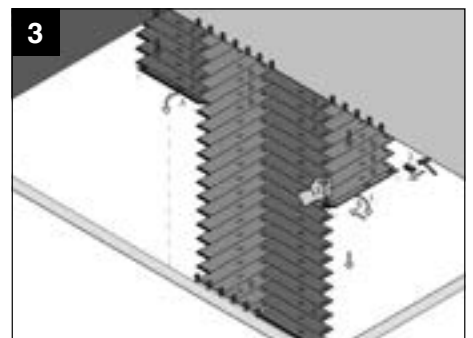
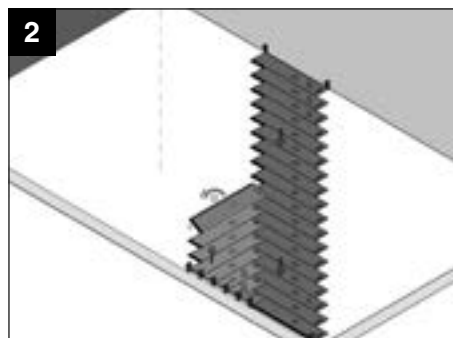
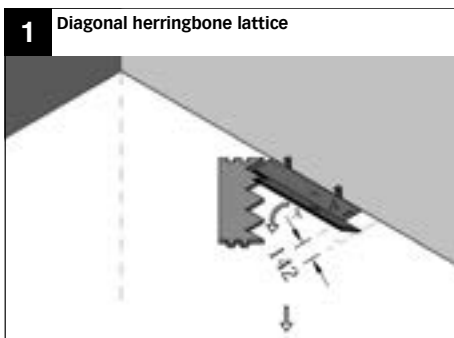
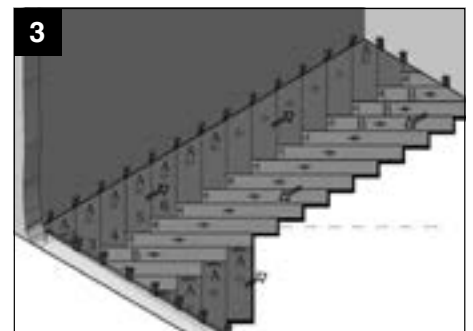
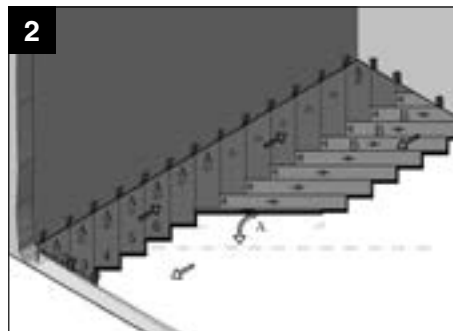
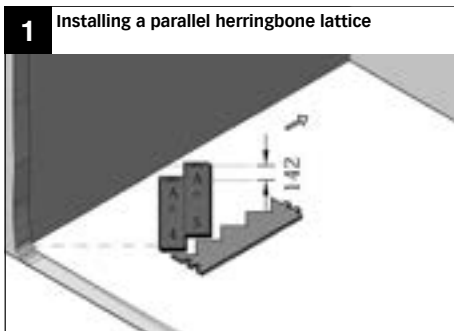
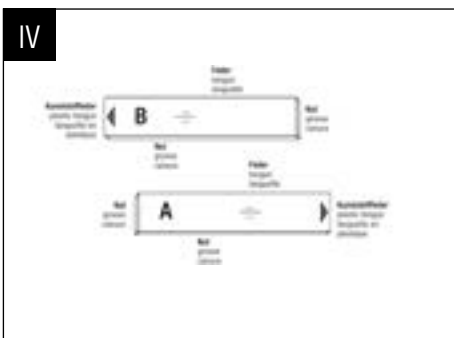
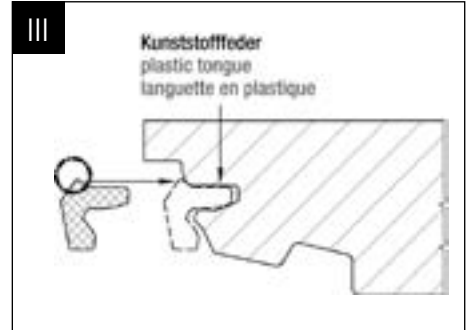
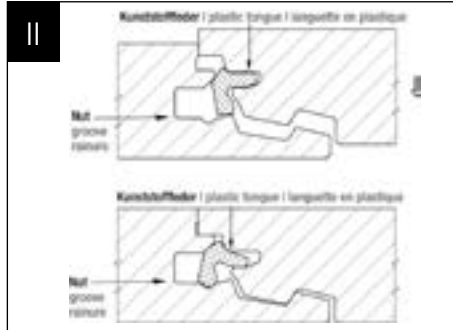
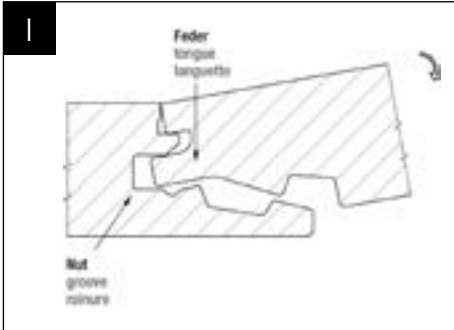

Attention: Please heed the up-to-date installation instructions included in the packaging.

MEISTER Longlife parquet Residence PS 400 with Uniclic technology



You need the following tools and aids to install MEISTER Longlife parquet PS 400 with Uniclic technology

Hammer, keyhole or electric saw, possibly power drill, folding metre rule, pencil, wedges (spacer wedges), tension iron, angle or adjustable bevel, possibly PE film (0.2 millimetres).

Use MEISTER foam film, MEISTER-Silence 15 DB, MEISTER-Silence 20, MEISTER-Silence 25 DB or MEISTER Duo-Guard as a cushioning layer. (When using MEISTER-Silence 25 DB, MEISTER-Silence 15 DB or MEISTER-Duo-Guard, additional 0.2 millimetre PE film is not required.)

Diagonal herringbone pattern

In order to obtain a uniform distance to all walls, draw a guide line using a chalk line (fig. 1). Start the laying process in a corner of the room. The tongue of board 1 has to be cut off both on the short and on the long side. On board 2, only the tongue on the long side has to be cut off. Now angle the short side of board 2 into the long side of board 1 (fig. 1). Then angle the long side of board 3 into board 1 (fig. 2). Now interlock the short side of board 3 into board 2 using the MEISTER tapping block (fig. 3). Follow this process to continue laying (fig. 4, 5, 6). Ensure that the long sides of the boards are angled in first before interlocking the boards on their short sides.

Lay the first herringbone pattern up to the wall/corner of the room (fig. 7). Any leftover board pieces could potentially be used to start the next herringbone pattern. Mark the leftover pieces on the reverse side indicating right or left positioning. The first herringbone pattern has to be fixed with spacers so that the herringbone pattern does not slide during the subsequent laying process.

Before starting with the next herringbone pattern, check if there are any leftover pieces that could be used. While continuing with the laying, ensure that the lengthways of the boards are angled in first and only then interlock the short sides (fig. 8).

Following this sequence, lay the surface up to the end of the room (fig. 9). The boards ending directly at the wall are cut in such a way that a 15mm gap to the wall is taken into account.

Parallel herringbone pattern

In order to obtain a uniform distance to all walls, draw a guide line using a chalk line (fig. 6).

Start the laying process in the middle of the room facing a wall. Angle the short side of board 2 into the long side of board 1 (fig. 1). Then angle board 3 lengthways into board 1 (fig. 2). Now interlock the short side of board 3 using the MEISTER tapping block into board 2 (fig. 3). Follow this process to continue laying up to board 11 (fig. 4, 5, 6).

Saw off the laid boards at a right angle and then align them at the guide line (fig. 6). Ensure that the boards are angled in lengthways first before interlocking them at their short side.

Lay the first herringbone pattern up to the facing wall (fig. 7). Any leftover board pieces could potentially be used to start the next herringbone pattern. Mark the leftover pieces on the reverse side indicating right or left positioning. The first herringbone pattern has to be fixed with spacers so that the herringbone pattern does not slide during the subsequent laying process.

Before starting with the next herringbone pattern, check if there are any leftover pieces that could be used. While continuing with the laying, ensure that the lengthways of the boards are angled in first and only then interlock them short sides (fig. 8).

Following this sequence, lay the surface up to the end of the room (fig. 9). The boards ending directly at the wall are cut in such a way that a 15mm gap to the wall is taken into account.

Before attaching the skirting boards, the timber wedges along the walls have to be removed.

To cover the all-round expansion joints, use MEISTER real wood veneered skirting boards (see page 30).

Please ensure that no silicon products whatsoever come into contact with the mouldings.

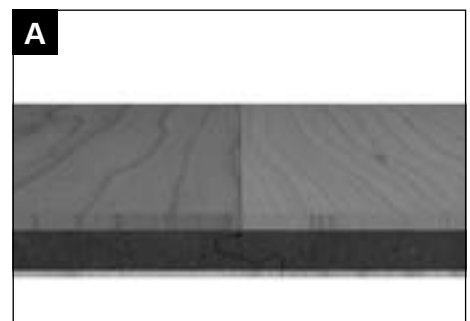
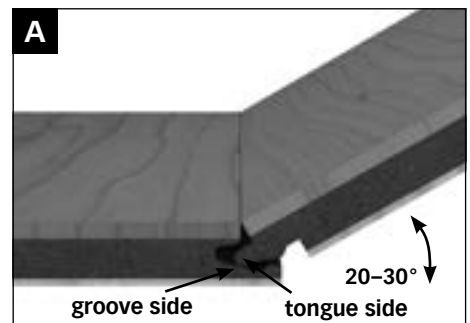

1 Diagonal herringbone pattern



2



3



4



5



6



7



8

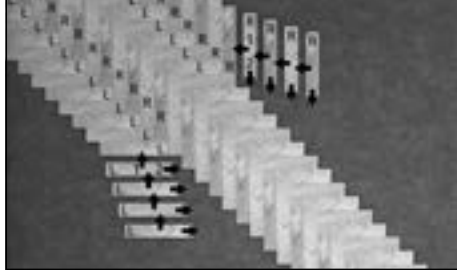

9



1 Parallel herringbone pattern



2



3



4



5



6

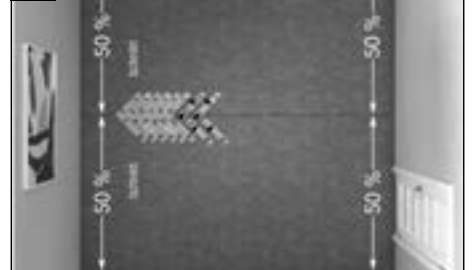

7



8

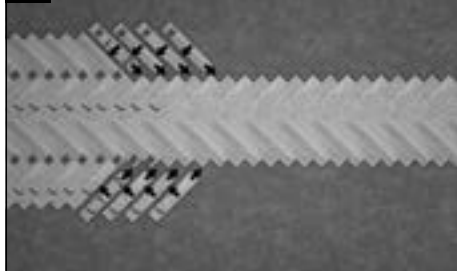

9



MEISTER Longlife parquet Penta PD 550 with longitudinal Uniclic technology

You need the following tools and aids to install MEISTER Longlife parquet PD 550 with longitudinal Uniclic technology:

Hammer, keyhole or electric saw, possibly power drill, folding metre rule, pencil, MEISTER tapping block, wedges (spacer wedges), tension iron, angle or adjustable bevel, possibly PE film (0.2mm), possibly D3 waterproof wood glue for naturally-oiled parquet flooring or Meistercoll special glue for UV-oiled parquet flooring.

For sound insulation, we recommend MEISTER Silence 25 DB.

General information

The planks have a tongue and groove joint on each end. These joints must always be glued. To do this, apply glue evenly to the bottom edge of the groove (fig. B). Please take care that no glue gets onto the wear layer. If any glue oozes out from the joint, remove it at once with a clean, damp cloth. Due to the different widths of plank, an installation plan must be compiled before laying the floor to avoid unnecessary cutting.

Step 1

Start by laying the first complete plank in the left-hand corner of the room with the tongue sides facing the wall. Saw the tongues off the long edges of the first row of planks to ensure you keep the right gap to the wall. Using wedges, you can easily keep a gap of 15 millimetres to the wall (fig A1).

Step 2

Insert the end of the next complete plank into plank 1 using a hammer and tapping block (fig. 2). To do this, first apply glue evenly to the bottom edge of the groove (fig. B). Lay the other planks in this row in the same way across the entire width of the room. Join the last piece of plank using a tension iron.

Step 3

Make sure the planks in the first row are straight. Remember that the end joints must be offset by at least 40 centimetres. Then place the next plank against row 1 and press the plank down slowly, using a forward and downward turning motion. (fig. 3). The plank should lock into the previously laid row (fig. 4).

Step 4

Similarly, the next complete plank is turned into the click connection on the long side and pushed tight against the previous plank before it is lowered. (fig. 5).

Step 5

Then press the plank down slowly, using a forward and downward turning motion (fig. 6). The plank should lock into the previously laid row.

Step 6

Insert the end of this plank into the previous plank and ensure the joint is tight with a hammer and tapping block (fig. 7). To do this, first apply glue evenly to the bottom edge of the groove (fig. B). Continue in this way across the entire width of the room.

Step 7

Install the whole area row by row in this way. Remember that the end joints must be offset by at least 40cm. Cut the last plank in each row so that you leave a gap of at least 15 millimetres to the wall. To cut the last row to size, use a spare piece of plank and draw the remaining plank width on it (leaving at least a 15-millimetre gap to the wall). Join the last piece of plank using a tension iron.

Step 8

Before attaching the skirting boards, the timber wedges along the walls have to be removed.

To cover the all-round expansion joints, use MEISTER real wood veneered skirting boards (see page 30).

Please ensure that no silicon products whatsoever come into contact with the mouldings.

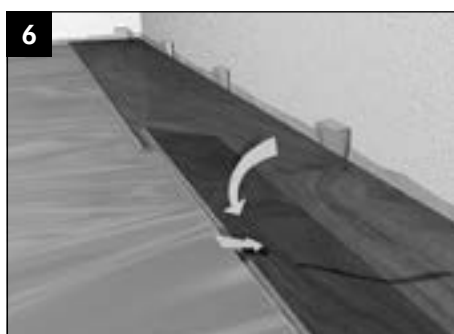
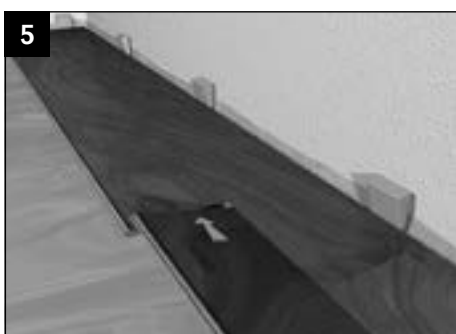
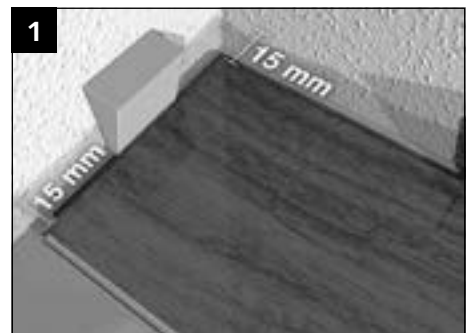
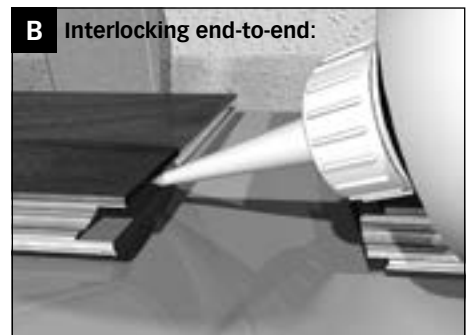
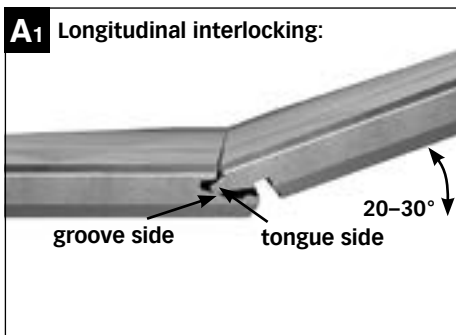

Laying instructions for fastening Longlife parquet Penta PD 450, Cottage PD 400, Classic PD 200, PD 150, PC 200, Residence PS 300, Style PC 400 (staple TOP 13) Lindura wood flooring HD 300 (staple TOP 11) to the wall

Preparatory measures

The packages must be acclimatised before you open them. Store them for approx. 48 hours (3-4 days in winter) flat on the floor in the centre of the room you want to work in. Do not store the packages in front of damp or freshly wallpapered walls. Before you install the planks, the conditions must comply with the general requirements for the installation of wooden materials in interior rooms. Make sure that the walls are dry, i.e. contain a maximum residual moisture of 5 percent. All windows and doors must also have been installed and a room temperature of approx. 20°C and approx. 30 – 65 percent relative humidity must prevail.

During installation, make sure that air can also circulate behind the wood panelling (possibly provide lath backing structure). You must avoid trapped air. It is also important during installation that you allow a gap of at least 10 – 15 mm next to all walls and other fixed elements. You need an expansion joint if your installation surface is longer or wider than 10 metres.

Sub-structure with batten profile type 8

Place the batten profile type 8 at maximum intervals of 40 centimetres apart (fig. 1). Please use suitable plugs or screws to screw the sub-structure to the wall at intervals of 50 cm. Correct any slight unevenness in the wall by placing spacers or wooden wedges underneath the laths. Use a standard metal hacksaw or one-hand angle grinder with metal cutting disc to trim the profile. A minimum gap of 20 mm is required when installing MEISTER recessed lights. This must be guaranteed by fixing the batten profile to the wall using a space of at least 12 mm.

Installation

As a result of the Masterclik Plus system the planks are installed from right to left (fig. 9). Start by laying the first complete plank with the tongue side facing the floor. With all the planks in the first row remove the tongues along the long edges.

To install the first row use the start/end clip. To fix these mark the profile's position on the back of the plank. The middle of the rail is marked using a pencil (fig. 2) and the start/end clip is fixed using the supplied screws (fig. 3). Tighten the screws but do not over tighten them. Then simply clip the plank into the batten profile (fig. 4). If the clip does not slot in correctly then the profile may have been pressed together during trimming. In this case please bend open the profile to its original dimensions again. Use the TOP 13|TOP 11 clip to fix the planks for the rest of the installation. For this simply screw the clip onto the batten profile (fig. 5) and push it onto the plank groove (fig. 6 + 7). Make sure that the planks in the first row are straight.

Angle the tongue of the first plank in the second row into the groove of the previous row of planks (fig. 8) and slowly press the planks onto the batten profile. Use the TOP 13|TOP 11 clip to fix the planks for the rest of the installation (fig. 7). Continue installing the planks row by row in this way (fig. 10). To cut the last row to size use a spare piece of a plank and draw the remaining plank width on it (leaving a gap of 10-15 mm to the ceiling).

Taking the plank marked for width, push the plastic end tongue forward out of the end groove using the spare piece of plank (fig. 11). Begin cutting the plank to size at the end of the plastic tongue. After the plank has been cut to size, push the plastic tongue on the end back into the end groove (fig. 12 + 13).

To install the start/end clips on the last row mark the position of the batten profile using a piece of adhesive tape (fig. 14) and transfer the position of the profile onto the back of the plank (fig. 15 + 16). Now the clip is fixed on the plank in the first row (fig. 17) and inserted into the plank (fig. 18). Afterwards the plastic tongue in the last row must be fixed using a screwdriver (fig. 19).

Use the MEISTER angled cover moulding for example to cover the all-round expansion joints (fig. 20 + 22).





Fig. 1



Fig. 2



Fig. 3



Fig. 4



Fig. 5



Fig. 6



Fig. 7



Fig. 8



Fig. 9

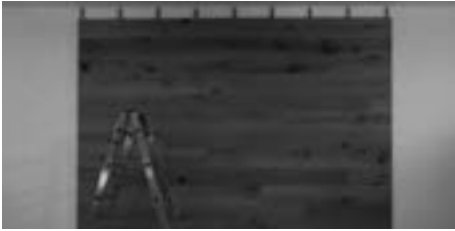

Fig. 10



Fig. 11



Fig. 12



Fig. 13



Fig. 14



Fig. 15



Fig. 16



Fig. 17

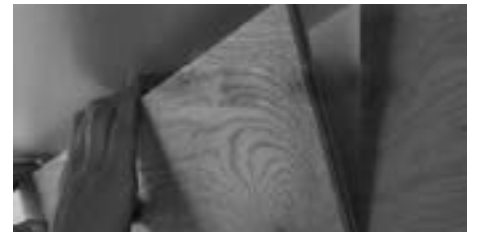

Fig. 18



Fig. 19



Fig. 20



Fig. 21



Fig. 22

MEISTER cork, linoleum, design, Nadura and laminate flooring with Mastercllic Plus technology



You need the following tools and aids to install MEISTER cork, linoleum, design, Nadura and parquet flooring with Mastercllic Plus technology.

Keyhole or electric saw, possibly power drill, folding metre rule, pencil, wedges (spacer wedges), angle or adjustable bevel, possibly PE film (0.2 millimetres).

If the product does not already have an impact sound lining, you have to use MEISTER foam film, MEISTER-Silence 15 DB, MEISTER-Silence 20, MEISTER-Silence 25 DB or MEISTER Duo-Guard as a cushioning layer. (If you use MEISTER Silence 25 DB, MEISTER Silence 15 DB or MEISTER Duo-Guard, you do not need an additional layer of 0.2-millimetre PE film.)

Step 1

Start by laying the first complete plank in the left-hand corner of the room with the tongue sides facing the wall. Remove only the tongues on the long sides of all the other planks you want to lay in the first row. Using wedges, you can easily keep a gap of at least 10 millimetres or 1.5mm per metre from the wall (fig. 1).

Step 2

Insert the end of the next complete plank into plank No. 1 (fig. 2). Lay the other planks in this row in the same way across the entire width of the room.

Step 3

Cut the last plank in each row so that you leave a gap of at least 10 millimetres to the wall (fig. 3). You can use cut-off pieces of planks, as long as they are at least 40 centimetres (with Nadura flooring NB 400 and cork flooring KC 85 S 30 centimetres) long, to start subsequent rows.

Step 4

Make sure the planks in the first row are straight. Cut the first plank in the second row to approx. 80 centimetres (with Nadura flooring NB 400 and cork flooring Classic KC 85 S to approx. 50-60 centimetres). Fix this plank upright with the spring as far as possible into the groove on the groove side of the previous row of planks and press the plank down slowly, using a forward and downward turning motion (fig. 4). The plank should lock into the previously laid row (fig. 5).

Step 5

Similarly, the next complete plank is turned into the click connection on the long side and the end pushed tight against the previous plank before it is lowered. Then press the plank down slowly, using a forward and downward turning motion (fig. 6). The plank must lock into the row previously laid and the end joint must fit tightly into the previous plank.

Step 6

Lay the flooring row by row in this way. Remember that the end joints must be offset by at least 40 centimetres (with Nadura flooring NB 400 and cork flooring Classic KC 85 S 25 centimetres) (fig. 7).

Step 7

To cut the last row to size, use a spare piece of plank and draw the remaining plank width on it (leaving at least a gap of 10 millimetre or 1.5mm per metre to the wall).

Step 8

Taking the plank marked for width, push the plastic end tongue forward out of the end groove with the aid of a spare piece of plank (fig. 8).

Step 9

Begin cutting the plank to size at the end of the plastic tongue (fig. 9). After the plank has been cut to size, push the plastic tongue on the end back into the end groove (fig. 10).

Step 10

Begin laying the last row in the right hand corner of the room (leaving at least a gap of 10 millimetres or 1.5mm per metre to the wall) and angle the sides of the plank into the second-last row. The next plank is pivoted in in the same way and lowered down at the end (fig. 11).

Step 11

Push the plastic tongue which is pointing out towards the wall (fig. 12) back into the end connection using a tension rod, scraper, screw driver or similar (fig. 13).

Step 12

Before attaching the skirting boards, the timber wedges along the walls have to be removed.

To cover the all-round expansion joints, use MEISTER skirting boards with colour-matching decorative surfaces (see page 30).

Please ensure that no silicon products whatsoever come into contact with the mouldings.

To take a plank row back out again, lift the entire row, levering it at the side out of the last row (fig. 14). Then you can separate the planks' ends by angling them (fig. 15). Should you wish to reuse the disassembled planks, you should push the end plastic spring flush back into the top groove.

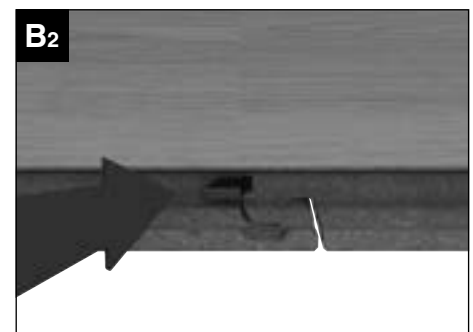
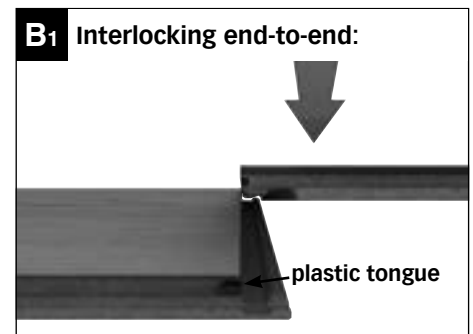
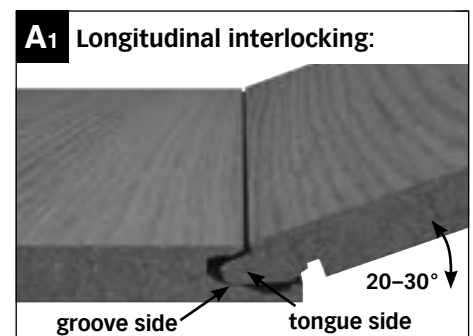

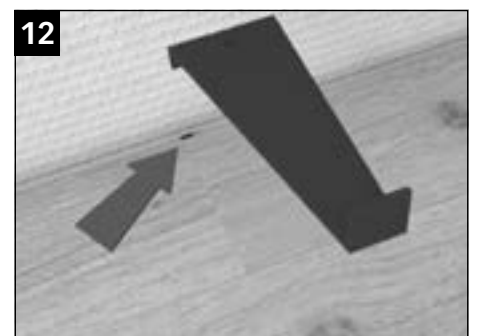
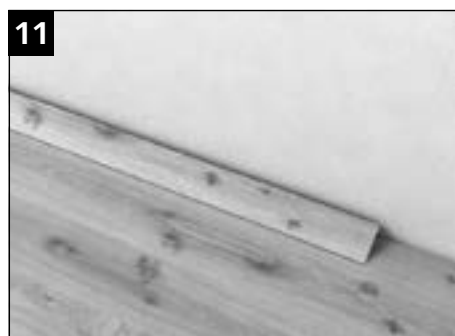
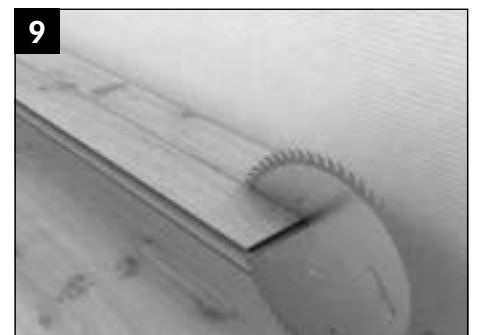
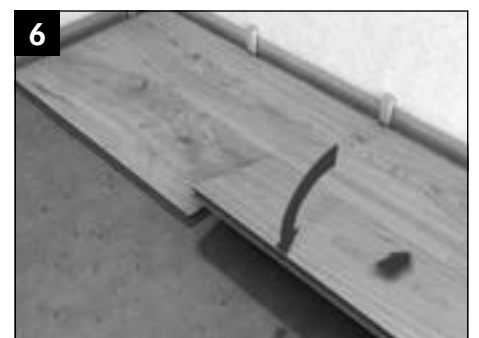

MEISTER laminate flooring with Multiclic technology



You need the following tools and aids to install MEISTER laminate flooring with Multiclic technology.

Hammer, keyhole or electric saw, possibly power drill, folding metre rule, pencil, wedges (spacer wedges), tension iron, angle or adjustable bevel, possibly PE film (0.2 millimetres). If the product does not already feature a sound-absorbing cushioning, use MEISTER foam film, MEISTER-Silence 15 DB, MEISTER-Silence 20, MEISTER-Silence 25 DB or MEISTER Duo-Guard as a cushioning layer. (When using MEISTER-Silence 25 DB, MEISTER-Silence 15 DB or MEISTER-Duo-Guard, additional 0.2 millimetre PE film is not required.)

Step 1

Start by laying the first complete plank in the left-hand corner of the room with the tongue sides facing the wall. Saw the tongues off the first plank, both on the short and the long side (fig. E). Remove only the tongues on the long sides of all the other planks you want to lay in the first row. Using wedges, you can easily keep a gap of at least 10mm or 1.5mm per metre with the wall.

Step 2

Join the next complete plank to the end of plank 1 using a tapping block and a hammer. Lay the other planks in this row in the same way across the entire width of the room. Wherever space is too tight to work with a hammer and tapping block, you can use a tension iron to help click the end joint in place.

Step 3

Make sure the planks in the first row are straight (fig A). Cut the first plank of the second row down to approx. 80cm. To install the second row, insert the long tongue into the groove of the first row of planks (fig. B, ①).

Step 4

By moving the plank slightly up and down, angle it completely into the already laid row of planks (fig. B, ②).

Step 5

Again, angle the next complete plank of the second row first on its long edge against the previously laid plank. Always make sure the long joint is tight. Once you have angled in the planks (fig. C, ① and ②) so they lie flat on the subfloor, click the ends together using the tapping block and light taps with the hammer (fig. C, ③).

Step 6

Install the whole area row by row in this way. Install the planks row by row until you have covered the whole room - always first fitting the long tongue into the groove and then joining the plank ends together. Remember that the end joints must be offset by at least 40 centimetres. to ensure the overall area is more stable (fig. D).

Step 7

Cut the last plank in each row so that you leave a gap of at least 10mm or 1.5mm per metre to the wall. To cut the last row to size, use a spare piece of plank and draw the remaining plank width on it (leaving at least a gap of 10mm or 1.5mm per metre to the wall). After you have laid the last planks, you can walk on the floor straight away and start attaching the skirting boards.

Step 8

Finally, remove the wooden wedges from around the walls.

To cover the all-round expansion joints, use MEISTER skirting boards or clip-on skirting boards with colour-matching decorative surfaces (see page 26). Please ensure that no silicon products whatsoever come into contact with the mouldings.

To take a plank row back out again, lift the entire row, levering it at the side out of the last row. Then you can separate the planks' ends by angling them. This way, the locking system remains intact and the planks can be refitted.

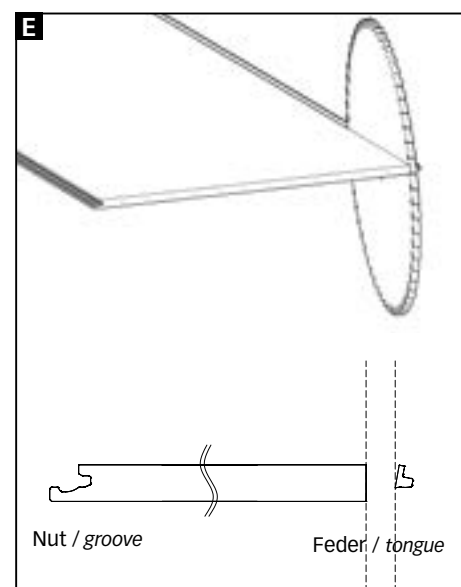
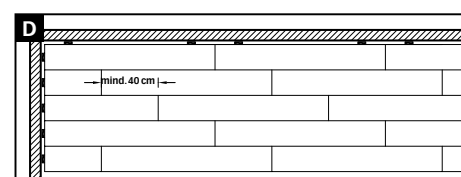
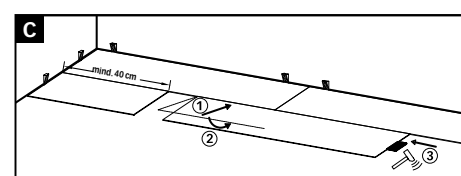
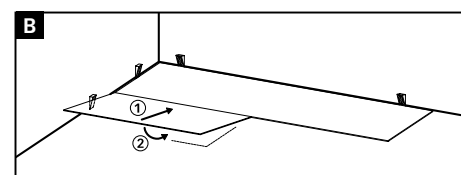
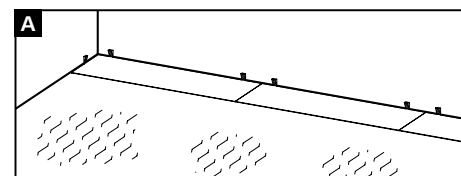

① Join the tongue on the long side

② Angle in

③ Join the ends

MEISTER design flooring with Multiclic technology

MULTICLIC®

You need the following tools and aids to install MEISTER design flooring with Multiclic technology.

Hammer, keyhole or electric saw, possibly power drill, folding metre rule, pencil, wedges (spacer wedges), tension iron, angle or adjustable bevel, **MEISTER 5mm tapping block**, possibly PE film (0.2 millimetres).

If the product does not already feature a sound-absorbing cushioning, use MEISTER-Silence 15 DB, MEISTER-Silence 20 or MEISTER-Silence 25 DB as a cushioning layer. (When using MEISTER-Silence 25 DB or MEISTER-Silence 15 DB additional 0.2 millimetre PE film is not required.)

Any other cushioning layers must have a suitable pressure stability (CS-value ≥ 60 kPa) and be 1 - 3 mm thick.

Step 1

Start by laying the first complete plank in the left-hand corner of the room with the tongue sides facing the wall. Saw the tongues off the first plank, both on the short and the long side (fig. F). Remove only the tongues on the long sides of all the other planks you want to lay in the first row. Using wedges, you can easily keep a gap of at least 10mm or 1.5mm per metre with the wall.

Step 2

Join the next complete plank to the end of plank 1 using the 5mm tapping block and a hammer. Lay the other planks in this row in the same way across the entire width of the room. Wherever space is too tight to work with a hammer and tapping block, you can use a tension iron to help click the end joint in place.

Step 3

Make sure the planks in the first row are straight (fig A). Cut the first plank of the second row down to approx. 80cm. To install the second row, insert the long tongue into the groove of the first row of planks (fig. B, ①).

Step 4

By moving the plank slightly up and down, angle it completely into the already laid row of planks (fig. B, ②).

Step 5

Again, angle the next complete plank of the second row first on its long edge against the previously laid plank. Always make sure the long joint is tight. Once you have angled in the planks (fig. C ① and ②) so they lie flat on the subfloor, start by installing the first plank in the third row. As soon as you have angled in and laid this plank (fig. D ① and ②), click the second plank in the previous row together at the ends using the 5mm tapping block and light taps with the hammer (fig. D ③).

Step 6

Install the whole area row by row in this way. Install the planks row by row until you have covered the whole room - always first fitting the long tongue into the groove and then joining the plank ends together. Before you click the plank together at the ends using the hammer and tapping block, a plank should already be angled into the next row (guide plank fig. D). Remember that the end joints must be offset by at least 40 centimetres to ensure the overall area is more stable (fig. E).

Step 7

Cut the last plank in each row so that you leave a gap of at least 10mm or 1.5mm per metre to the wall. To cut the last row to size, use a spare piece of plank and draw the remaining plank width on it (leaving at least a gap of 10mm or 1.5mm per metre to the wall). After you have laid the last planks, you can walk on the floor straight away and start attaching the skirting boards.

Step 8

Finally, remove the wooden wedges from around the walls.

To cover the all-round expansion joints, use MEISTER skirting boards or clip-on skirting boards with colour-matching decorative surfaces (see page 26). Please ensure that no silicon products whatsoever come into contact with the mouldings.

To take a plank row back out again, lift the entire row, levering it at the side out of the last row. Then you can separate the planks' ends by angling them. This way, the locking system remains intact and the planks can be refitted.

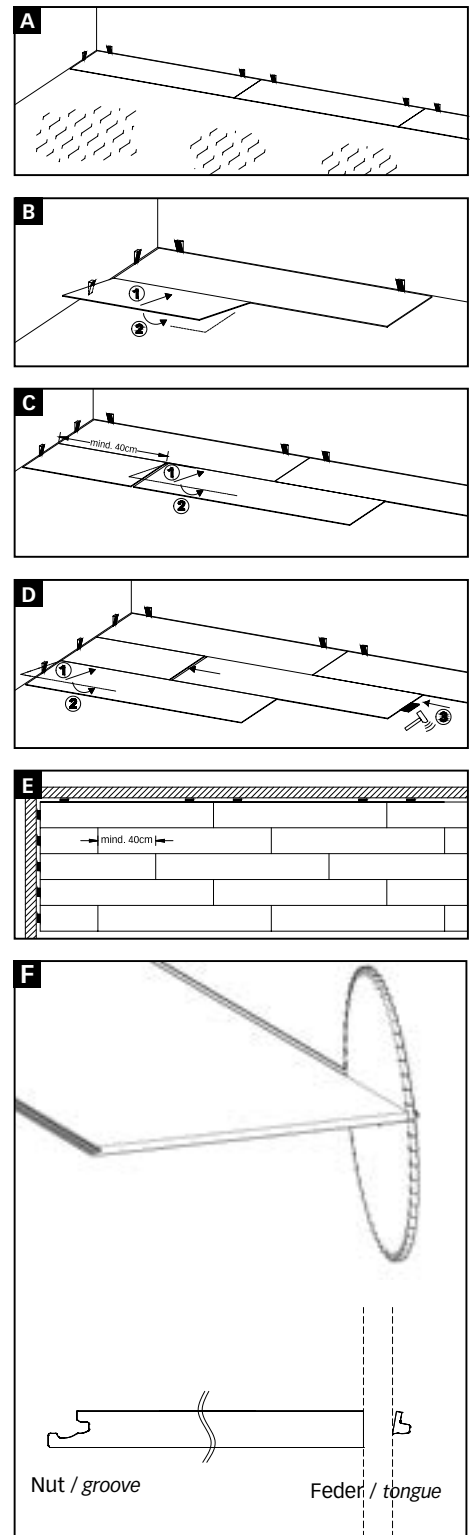

- ① Join the tongue on the long side
- ② Angle in
- ③ Join the ends

MEISTER Nadura flooring NQ 500 with Quadroclig Plus technology

QUADROCLIGPLUS®

You need the following tools and aids for installing MEISTER Nadura flooring: Hammer, keyhole or electric saw, carbide tipped saw blades or diamond-tipped saw blades, possibly power drill, folding metre rule, pencil, MEISTER "Quadroclig" tapping block wedges, tension iron, angle or adjustable bevel, possibly PE film (0.2mm).

If the product does not already feature a Silence backing, you can use MEISTER-Silence 15 DB, MEISTER-Silence 20 or MEISTER-Silence 25 DB as a cushioning layer. Any other cushioning layers must have a suitable pressure stability (CS-value ≥ 15 kPa) and be 1 - 3mm thick.

General information

The Quadroclig Plus click connection (fold down system) allows you to work quickly and safely. This product's square shape is ideal for installation in chessboard format. It is also possible to install it in different laying patterns. Generally the squares are angled in (fig. I) and lowered (fig. II) and instantly locked by applying pressure from above. The squares can be angled in and pivoted out. In addition, it may be necessary to tap them together using the matching "Quadroclig" tapping block, e.g. in specific installation situations such as in the area around door frames etc. It may also be required to remove the plastic tongue here. If you want to reuse the disassembled planks, you have to manually reinsert the plastic tongue into the middle of the groove again (fig. III).

Step 1

There are 3 squares each labelled type A and type B on the back (fig. IV) in every packet. Start by installing the first complete type A square in the left-hand corner of the room with the tongues facing the wall (plastic tongue facing the left-hand wall) (fig. 1). Using the wedges you can easily maintain a gap of at least 10 millimetres to the wall.

Step 2

Angle the next complete type B square into the first square with the plastic tongue facing the wall and slowly press it down using a forwards and downwards movement (fig. 2). It locks into the click connection. Install the entire row in the same way, alternating between type A and type B squares (fig. 3).

Step 3

The last planks in each row are cut to size so that a gap of 10 millimetres to the wall is taken into account. If you want a symmetrical installation pattern, you have to join the rows accordingly.

Step 4

Make sure that the squares in the first row are straight. Start the second row with a type B square and insert it into the previous square with the plastic tongue (fig. 4).

Step 5

The next complete type A square is angled into the first row with the tongue and lowered into the previous square with the plastic tongue side (fig. 5).

The whole room is installed by angling the new squares to be installed into the previous row and simply lowering into the square to the left, applying slight pressure from above if necessary (hand or hammer, do not damage the surface).

Step 6

To cut the last row to size use a spare piece of a plank and draw the remaining plank width on it (leaving a gap of at least 10 mm to the wall).

Step 7

Finally, remove the wooden wedges from around the walls. To cover the all-round expansion joints, use MEISTER skirting boards or clip-on skirting boards with colour-matching decorative surfaces (see page 30).

Please ensure that no silicon products whatsoever come into contact with the mouldings.

To disassemble the flooring you have to twist the whole row out of the profile from above. You can then pivot the squares out. The locking mechanism remains intact as a result, although the plastic tongue has to be manually pressed into the middle of the groove again (fig. III).

For installation without a chessboard format please always install type A squares (from left to right) and type B squares (always from right to left) in rows. As a result the plastic tongue is always facing the element that has already been installed and automatically clicks in when lowered.

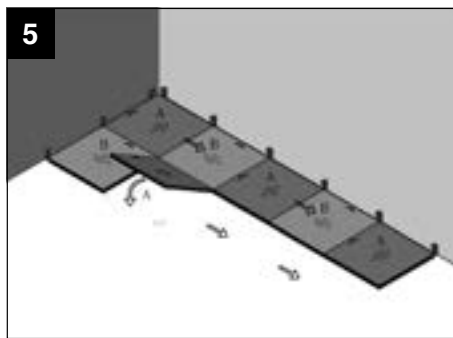
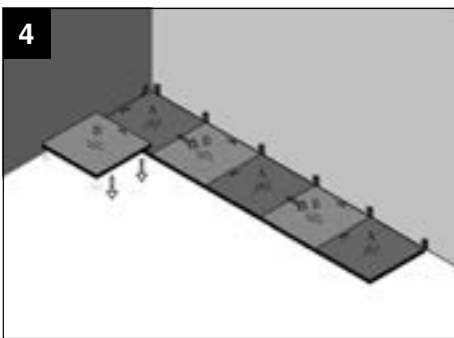
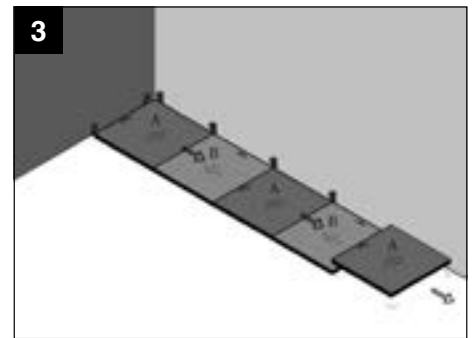
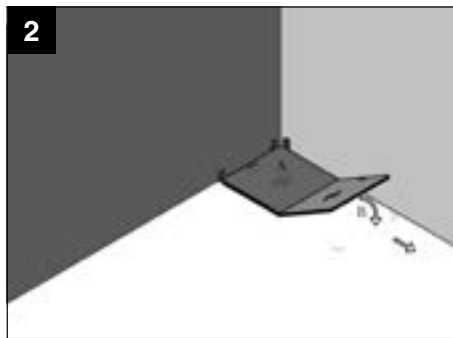
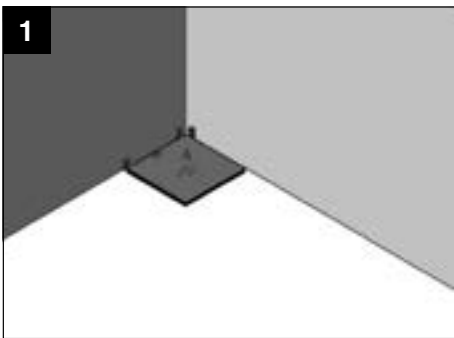
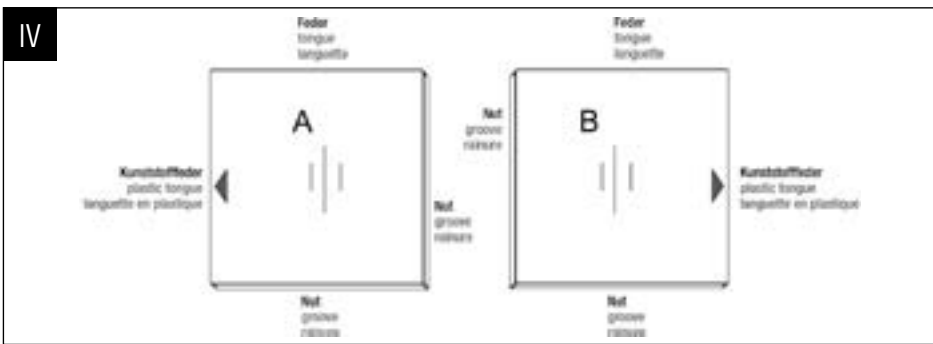
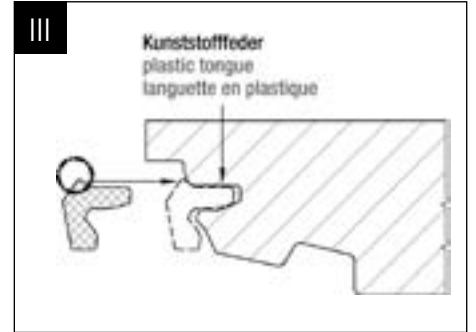
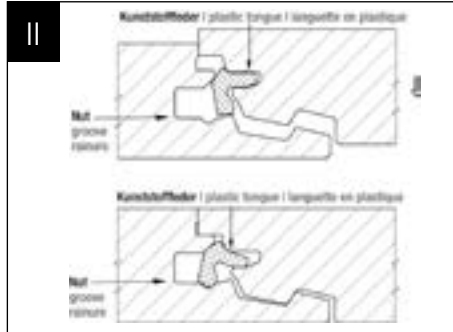
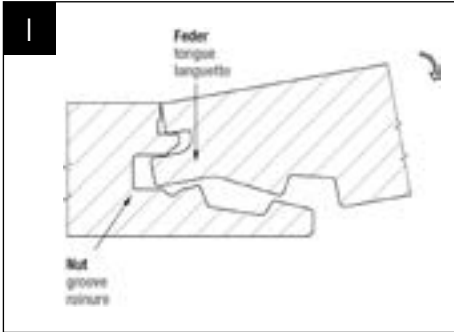

Laminate flooring Melango, Micala and Talamo in humid rooms with Masterclic Plus technology

The laying instructions for Masterclic Plus (see page 20) and the general notes and preparatory measures must be observed.

So-called "humid rooms" are all rooms with higher but not permanent moisture and/or with periodically high humidity e.g. bathrooms. This does not include outdoor areas and wet rooms, e.g. saunas, shower cubicles, steam rooms and rooms with a floor drain.

All premium laminate flooring from MEISTER is suitable for humid rooms as they have the AquaSafe system's comprehensive protection against humidity. **Please note:** do not leave puddles of water/spills to dry on the surface but wipe up and wipe dry immediately (within 30 minutes). This also applies to wet and damp objects, including textiles, bath mats etc. In addition, any parts of the flooring which come into contact with sanitary cleaners, chemicals etc. must be wiped with clear water without delay.

Care must always be taken that no humidity gets under the flooring. For this reason, appropriate structural measures must be taken for floating installation in humid rooms. Edge joints are generally necessary to guarantee the flooring can expand, particularly in rooms with high humidity.

Wall ends and edge areas should preferably be fitted with suitable end, transition or joining profiles made of aluminium. To ensure the necessary seal against liquids, a pre-compressed PE sealing tape without plasticisers can be used, for example. This tape is glued under the cover profile. Once this has been screwed to the base profile, the result is a sealed finish with the flooring. The bottom profile must be glued to the adhesive and sealing tape of the respective sound-absorbing cushion.

Joints between the profile and the wall must be sealed water-impermeably using a permanently flexible sealing compound (plasticiser-free silicone). This also applies to the wall and edge areas where non of the above-mentioned aluminium profiles can be used. In such areas, a PE joint filler cord (plasticiser-free) must be used as to finish off. These expansion joints must also be sealed with sealing compound to prevent humidity penetration. Joints in the edge and wall area must always have a width of 10 mm to fixed building structures. This is a maintenance joint which, as a flexible joint, requires permanent maintenance and care. The term maintenance joint is used for all those joints which are exposed to heavy chemical and/or physical influences and whose sealants must be checked at regular intervals and renewed if necessary in order to avoid consequential damage.

With end profile

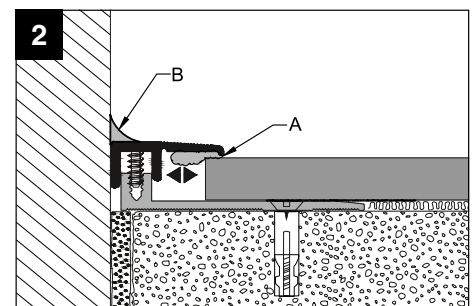
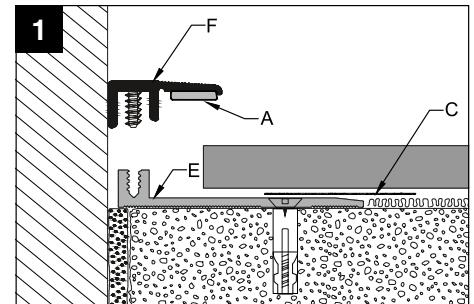

Without end profile

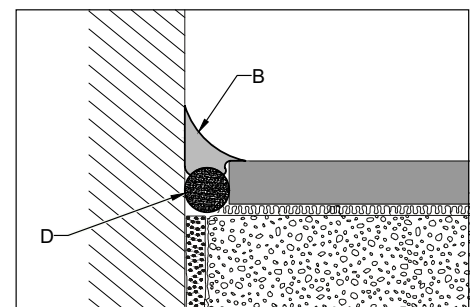

- A – Pre-compressed and plasticiser-free PE sealing tape
- B – Maintenance joint, permanently flexible, plasticiser-free silicone
- C – Adhesive tape for sound-absorbing cushion
- D – PE joint filler cord, plasticiser-free
- E – Bottom profile
- F – Cover profile

Notes:

Flooring profiles

If the floor area is longer or wider than 10m, then you must provide an expansion joint. This is covered with a jointing profile. The same applies in the area of doors, connecting passageways and polygon-shaped rooms. Two

adjacent rooms must usually be separated with a jointing profile. Use the transition profile to adjust to adjacent, lower lying areas or floor coverings. The end profile is ideal for clean finishes in front of higher, adjacent sills, tiles or

other raised floors. Use the stair edge profile to give stairs fitted with MEISTER flooring a clean finish.

Joining, end and transition profiles, anodised aluminium, matching all MEISTER flooring (except for: design flooring Catega® Flex DD 300 | DD 300 S as well as design flooring Classic DD 75 | DD 75 S, DC 75 | DC 75 S and DD 85 | DD 85 S)

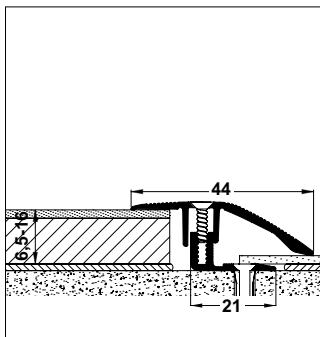

Joining profile type 200 (6.5 to 16mm)

Acts as a crossover to bridge the thickness difference of two flooring levels (e.g. carpet, linoleum etc.).

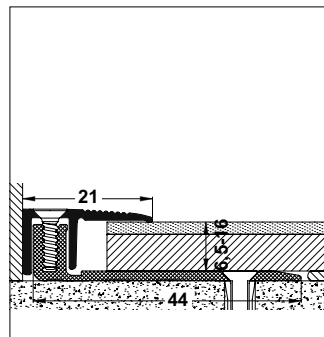

End profile type 201 B (6.5 to 16mm)

Broad bottom profile allows better fixing to substrate. For clean transitions to adjacent, higher thresholds, tiles, patio doors, floor-to-ceiling windows or the like.

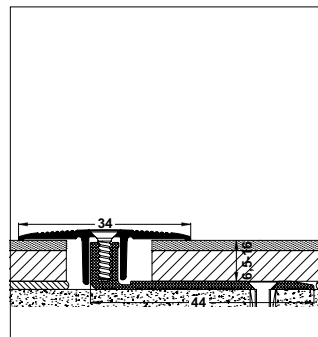

Transition profile type 202 B (6.5 to 16mm)

Broad bottom profile allows better fixing to substrate. For expansion joints: Bridges height differences of up to 3 mm.

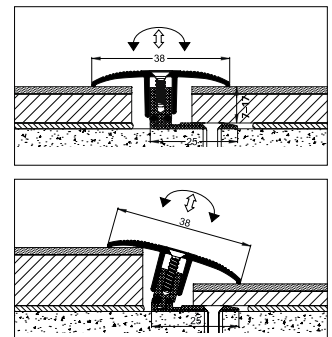

Transition profile Flexo type 302 (7 to 17mm)

For expansion joints: Suited for floor coverings between 7 and 17 mm (at equal covering height). Bridges height differences of up to 12 mm (e. g. from 23 mm to 8 mm or from 15 mm to 3 mm).

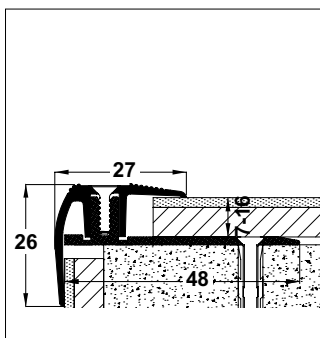

Stair profile type 203 (7 to 16mm)

Supplied as a 2-part profile system (cover and base element). Screws are provided.

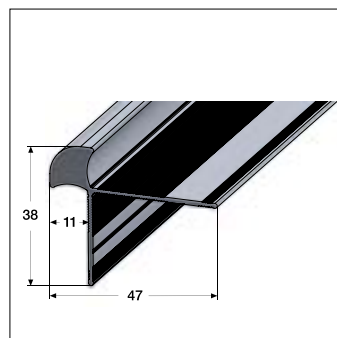

Stair profile type 11 (10 to 11mm)

Two-sided; discreet, visible edge; drilled countersunk, with grooves.

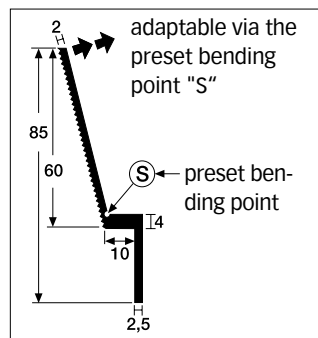

Sloping angle 3402

With adhesive grooves; natural-coloured aluminium; with countersunk drill holes; 20mm x 3.5mm Ø wood screws with cross-slot head are provided. Toughness: approx. 75N/sq.mm Length: 100cm

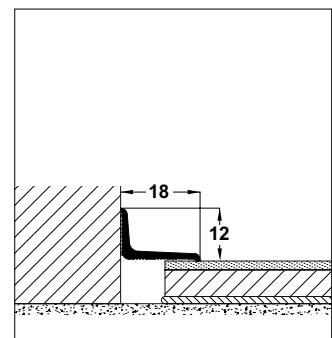

End profile type 300 SK (self-adhesive)

For clean edges in front of terrace doors or floor-length windows

Clip-on transition profile "Flexo" and end profile with a specially coated laminate film or anodised aluminium, matching all MEISTER flooring (except for: design flooring Catega® Flex DD 300 | DD 300 S as well as design flooring Classic DD 75 | DD 75 S, DC 75 | DC 75 S and DD 85 | DD 85 S)

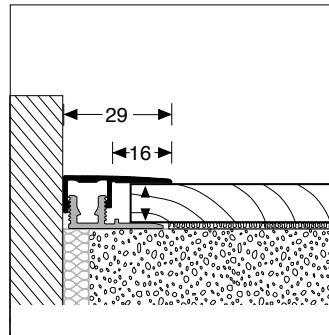
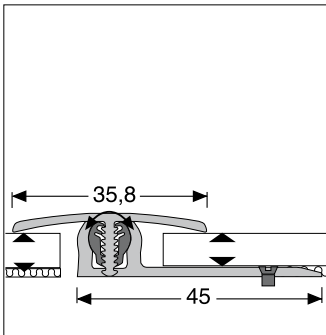

Clip-on transition profile "Flexo" type 402 (7 to 15mm)

Including 4-18mm height compensation. Height differences of up to 6mm can be bridged. Broad bottom profile enables a better fixation to the subfloor.

Clip-on end profile type 401 (7 to 18 mm)

For clean transitions to adjacent, higher thresholds, tiles or the like.

Joining, end and transition profiles, anodised aluminium, matching all MEISTER design flooring Catega® Flex DD 300 | DD 300 S as well as design flooring Classic DD 75 | DD 75 S, DC 75 | DC 75 S and DD 85 | DD 85 S

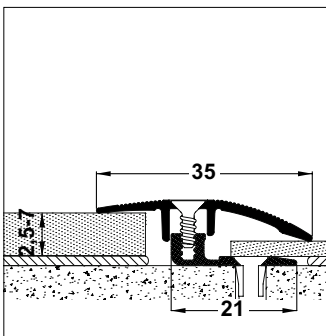

Joining profile type 100 (2.5 to 7mm)

Acts as a crossover to bridge the thickness difference of two flooring levels (e.g. carpet, vinyl, etc.).

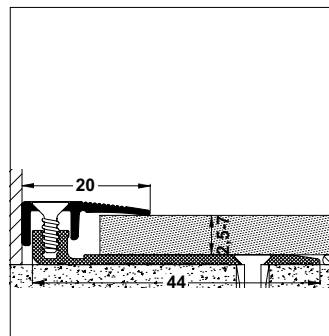

End profile type 101 (2.5 to 7mm)

For clean transitions to adjacent, higher thresholds, tiles, patio doors, floor-to-ceiling windows or the like.

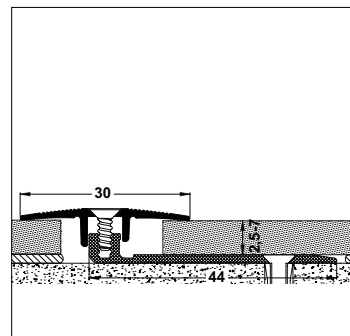

Transition profile type 102 (2.5 to 7mm)

Broad bottom profile allows better fixing to substrate
For expansion joints:
Bridges height differences of up to 3mm.

Wall transitions

To cover the expansion joints around the edges of MEISTER laminate flooring, use MEISTER clip-on skirting board profiles 1 to 3, for MEISTER Classic (LB 85) laminate flooring, we recommend MEISTER skirting board profiles 8 PK with matching decorative surface. For installation with MEISTER Longlife parquet and Lindura wood flooring, we offer matching real wood veneer MEISTER skirting board profiles 1 to 3.

To match MEISTER cork flooring, we also supply our cork-covered clip-on skirting board profiles 1 to 3. When installing MEISTER Nadura flooring, use MEISTER skirting board profile 8 PK. When installing MEISTER design flooring use the MEISTER skirting board profiles 2 PK and 3 PK with colour-matching decorative surface. The MEISTER skirting board profiles are a clean and sophisticated floor connector and can be

fitted with a clip, glued (with silicone-free assembly adhesive), nailed or screwed. A hollow space inside the attachment clips (PK) makes it possible to lay concealed cables through it. Please ensure that no silicon products whatsoever come into contact with the mouldings.

Skirting board – a perfect finish

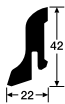

Skirting board
1 MK profile



Skirting board
2 PK profile



Skirting board
3 PK profile

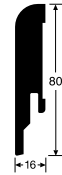

Skirting board
5 PK profile

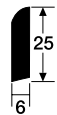

Skirting board
6 profile



Quadrant
7 profile

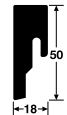

Skirting board
8 PK profile



Skirting board
9 PK profile



Skirting board
10 PK profile



Skirting board
11 PK profile

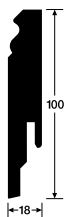

Skirting board
12 PK profile

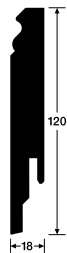

Skirting board
13 PK profile

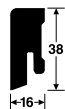

Skirting board
14 MK profile



Skirting board
15 MK profile



Skirting board
16 MK profile



Skirting board
17 profile



Skirting board
18 PK profile

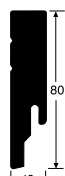

Skirting board
19 PK profile

Underlay material

Thanks to the special PUR mineral mixture the MEISTER Silence 25 DB, MEISTER Silence 20 or MEISTER Silence 15 DB are the perfect insulating underlay for effective sound absorption in the room and reduction of footfall transmitted to the rooms below. With MEISTER you not only find the right insulating underlay for your requirements but also films and a large selection of underlay materials for screed, wooden floors and other subfloors.

Product properties – underlay materials

Summary	Silence 25 DB	Silence 20	Silence 15 DB	Duo-Guard	Foam film	Plastic film
Material thickness approx.	3mm	2.5mm	2mm	2mm	2mm	0.2mm
Weight approx.	3kg/m ²	2.3kg/m ²	1.5kg/m ²	0.3kg/m ²	0.2kg/m ²	
Pressure resistance	approx. 150 kPa ●●●●	approx. 170 kPa ●●●●	approx. 220 kPa ●●●●●	approx. 50 kPa ●●●	approx. 45 kPa ●●●	–
Room noise improvement	●●●●●	●●●●	●●●	●●	●●	–
Footfall noise improvement	●●●●	●●●●	●●●	●●●	●●●	–
Suitability for underfloor heating	●●●●	●●●●	●●●●	●●	●●	●●●●●
Correction of unevenness	●●●●	●●●●	●●●	●●	●●	–
Humidity protection	✓	No	✓	✓	No	✓

Summary	Silence 25 DB	Silence 20	Silence 15 DB	Duo-Guard	Foam film	Plastic (PE) film
Weight approx.	3kg/m ²	2.3kg/m ²	1.5kg/m ²	0.3kg/m ²	0.2kg/m ²	
Wooden planks	–	✗	–	–	✗	–
Wood based boards, OSB boards, drywall elements	–	✗	–	–	✗	–
Mineral subfloors (e.g. cement screed, anhydride screed)	✗	✗ with plastic (PE) film	✗	✗	✗ with plastic (PE) film	✗
Mastic asphalt screed	–	✗	–	–	✗	–
Existing coverings (e.g. ceramic tiles and boards, natural stone, plastic)	✗	✗ with plastic (PE) film	✗	✗	✗ with plastic (PE) film	✗

Properties:

●●●●● Ideally suited ●●●● Very well suited ●●● Well suited ●● Suited ● Suited to a certain extent ✓ Available ✗ Suited – not suited

MEISTER Longlife parquet on warm water heated floor structures

The entire MEISTER Longlife parquet range is suitable for installation on warmwater underfloor heating.

Please follow the instructions below:

The PD 450, PD 400, PD 200, PD 150, PS 500, PS 300, PQ 500, PC 400 and PC 200 collections have a heat transfer resistance on MEISTER Silence 25 DB of 0.118m² K/W. The MEISTER floors in the PS 400 collections have a heat transfer resistance of 0.13m² K/W when laid with MEISTER foam film (2mm) together with MEISTER PE film (0.2mm).

Due to the natural warmth of the flooring, the heating can be switched off more often during moderately cold weather compared to heating under tiled floors. MEISTER flooring on hot-water underfloor heating reaches an even surface temperature all over. All types of wood are suitable for installation on hot-water underfloor heating – due to the natural swelling and shrinking properties of natural woods, open joints may appear. Especially maple and beech are more sensitive.

The floors must not be covered with any coverings, e.g. carpets, runners, mats or any other overlays as this may cause an accumulation of heat. These types of flooring react with deformations and warping.

When laying on hot water underfloor heating in commercial areas, we recommend the installation of a fidbox® (measuring device from floorprotector).

Preparatory measures:

Any room heated over a large area requires planning and coordination of the heating system, the screed and the various coverings, taking into account the type of use, in order to ensure optimum and fault-free functioning in the long term. When these special floor constructions are installed, professional standards are equally important. Supplies and processing steps must correspond with the latest technology, the available information sheets from the central association of the German construction trade and the assembly and installation guidelines of the relevant system suppliers and manufacturers.

Caution! In case of underfloor heating, the bottom profiles of the transition profiles etc. are fixed with mounting adhesive.

Screed – Checking moisture – Readiness for laying

After completion and a corresponding lying time, the screed can be heated. Complete drying out (readiness for laying) is an absolute prerequisite for the preparation and installation steps for MEISTER Longlife parquet and is therefore essential. The reason for this is that the moisture measurements to be carried out as part of subfloor checking cannot be reliably performed on heated constructions due to the risk of damage. This means that heated screed must be dried out by means of heating up and cooling down with a heating break before installation of any type of covering. To be ready for the installation of MEISTER flooring, the moisture content (according to DIN 4725, part 4 – measured with CM devices) of cement screed should be a maximum of 1.8 CM% and of anhydrite screed it should be a maximum of 0.3 CM%.

The moisture content limits also apply to fast-hardening cement and screed with screed additives – TKB technical briefing note 14.

Special measures

(heating up and cooling down)

The client must observe the following instructions and/or have them performed by the persons responsible:

- | The screed with underfloor heating must be heated up after its respective holding time in accordance with its specific data sheet.
- | During heating up, the initial temperature should be increased daily up to the full (maximum) heating power.
- | The pattern of the heating measure and the heating break must be carried out in accordance with the log of measures.
- | The time plan indicates the minimum period of heating up – each additional day is of further benefit and provides extra security.
- | MEISTER Longlife parquet must be installed in accordance with DIN 18 356, 18 365 and 18 367 at a screed surface temperature of at least 15°C and a relative humidity of 30 - max. 65%.
- | After installation of the flooring (completion), this climate must be maintained for one week (adhering and hardening time of adhesives and other material layers used).
- | After installation of MEISTER Longlife parquet, the maximum surface temperature of 29°C may not be exceeded.

Important note: The above points must be carried out according to the relevant rules and/or confirmed by specialists (architect, heating specialist etc.)

Structure of floating installation

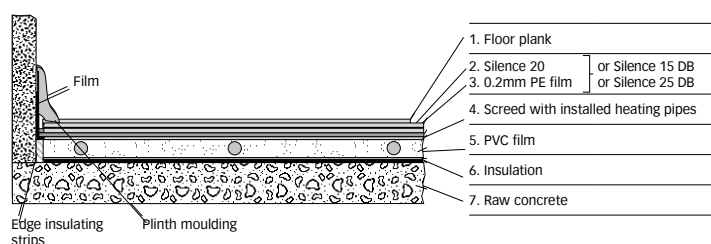

Structure of surface bonding

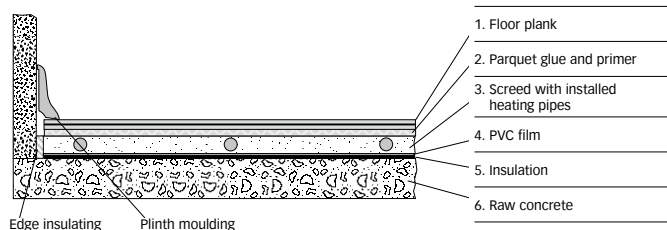

Note: Full surface bonding must be carried out by a professional.

MEISTER Lindura wood flooring on warm water heated floor structures

The MEISTER Lindura wood flooring is suitable for installation on hot-water underfloor heating.

Please follow the instructions below:

When installed with MEISTER-Silence 25 DB, MEISTER Lindura wood flooring has a heat transmission resistance of 0.084m² K/W. Due to the natural warmth of the flooring, the heating can be switched off more often during moderately cold weather compared to heating under tiled floors. MEISTER flooring on hot-water underfloor heating reaches an even surface temperature all over.

The floors must not be covered with any coverings, e.g. carpets, runners, mats or any other overlays as this may cause an accumulation of heat. These types of flooring react with deformations and warping.

When laying on hot water underfloor heating in commercial areas, we recommend the installation of a fidbox® (measuring device from floorprotector).

Preparatory measures:

Any room heated over a large area requires planning and coordination of the heating system, the screed and the various coverings, taking into account the type of use, in order to ensure optimum and fault-free functioning over the long term. When these special floor constructions are installed, professional standards are correspondingly important. Supplies and processing steps must correspond with the latest technology, the available information sheets from the central association of the German construction trade and the assembly and installation guidelines of the relevant system suppliers and manufacturers.

Caution!In case of underfloor heating, the bottom profiles of the transition profiles etc. are fixed with mounting adhesive.

Screed – Checking moisture – Readiness for laying

After completion and a corresponding lying time, the screed can be heated. Complete drying out (readiness for laying) is an absolute prerequisite for the preparation and installation steps for MEISTER Lindura wood flooring and is therefore essential. The reason for this is that the moisture measurements to be carried out as part of subfloor checking cannot be reliably performed on heated constructions due to the risk of damage. This means that heated screed must be dried out by means of heating up and cooling down with a heating break before installation of any type of covering. To be ready for the installation of MEISTER flooring, the moisture content (according to DIN 4725, part 4 – measured with CM devices) of cement screed should be a maximum of 1.8 CM% and of anhydrite screed it should be a maximum of 0.3 CM%.

The moisture content limits also apply to fast-hardening cement and screed with screed additives – TKB technical briefing note 14.

Special measures

(heating up and cooling down)

The client must observe the following instructions and/or have them performed by the persons responsible:

- | The screed with underfloor heating must be heated up after its respective holding time in accordance with its specific data sheet.
- | During heating up, the initial temperature should be increased daily up to the full (maximum) heating power.
- | The pattern of the heating measure and the heating break must be carried out in accordance with the measure protocol.
- | The time plan indicates the minimum period of heating up – each additional day is of further benefit and provides extra security.
- | MEISTER Lindura wood floorings must be installed in accordance with DIN 18 356, 18 365 and 18 367 at a screed surface temperature of at least 15°C and a relative humidity of 30 to max. 65%.
- | After installation of the flooring (completion), this climate must be maintained for one week (adhering and hardening time of adhesives and other material layers used).
- | After installation of MEISTER Lindura wood flooring, the maximum surface temperature of 29°C may not be exceeded.

Important note: The above points must be carried out according to the relevant rules and/or confirmed by specialists (architect, heating specialist etc.).

Structure of floating installation

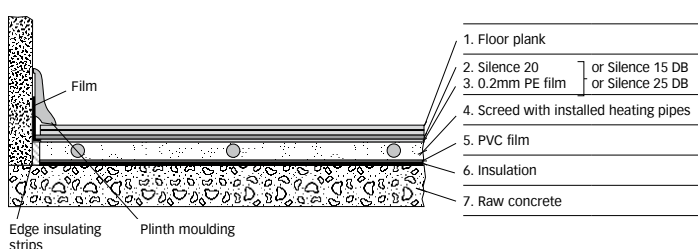

Structure of surface bonding

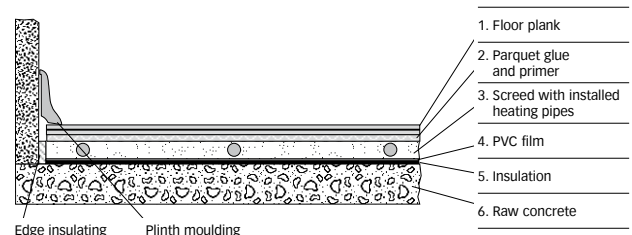

Note: Full surface bonding must be carried out by a professional.

MEISTER cork flooring on warm water heated floor structures

The MEISTER cork flooring is suitable for installation on hot-water underfloor heating.

Please follow the instructions below:

When installed with 0.2mm PE film, MEISTER flooring from the Puro KD 300 S and Classic KC 85 S collections has a heat transmission resistance of 0.11m² K/W. Due to the natural warmth of the flooring, the heating can be switched off more often during moderately cold weather compared to heating under tiled floors. MEISTER flooring on hot-water underfloor heating reaches an even surface temperature all over.

The floors must not be covered with any coverings, e.g. carpets, runners, mats or any other overlays as this may cause an accumulation of heat. These types of flooring react with deformations and warping.

When laying on hot water underfloor heating in commercial areas, we recommend the installation of a fidbox® (measuring device from floorprotector).

Preparatory measures:

Any room heated over a large area requires planning and coordination of the heating system, the screed and the various coverings, taking into account the type of use, in order to ensure optimum and fault-free functioning over the long term. When these special floor constructions are installed, professional standards are correspondingly important. Supplies and processing steps must correspond with the latest technology, the available information sheets from the central association of the German construction trade and the assembly and installation guidelines of the relevant system suppliers and manufacturers.

Caution! In case of underfloor heating, the bottom profiles of the transition profiles etc. are fixed with mounting adhesive.

Screed – Checking moisture – Readiness for laying

After completion and a corresponding lying time, the screed can be heated. Complete drying out (readiness for laying) is an absolute prerequisite for the preparation and installation steps for MEISTER cork flooring and is therefore essential. The reason for this is that the moisture measurements to be carried out as part of subfloor checking cannot be reliably performed on heated constructions due to the risk of damage. This means that heated screed must be dried out by means of heating up and cooling down with a heating break before installation of any type of covering. To be ready for the installation of MEISTER flooring, the moisture content (according to DIN 4725, part 4 – measured with CM devices) of cement screed should be a maximum of 1.8 CM% and of anhydrite screed it should be a maximum of 0.3 CM%.

The moisture content limits also apply to fast-hardening cement and screed with screed additives – TKB technical briefing note 14.

Special measures

(heating up and cooling down)

The client must observe the following instructions and/or have them performed by the persons responsible:

- | The screed with underfloor heating must be heated up after its respective holding time in accordance with its specific data sheet.
- | During heating up, the initial temperature should be increased daily up to the full (maximum) heating power.
- | The pattern of the heating measure and the heating break must be carried out in accordance with the measure protocol.
- | The time plan indicates the minimum period of heating up – each additional day is of further benefit and provides extra security.
- | MEISTER cork floorings must be installed in accordance with DIN 18 356, 18 365 and 18 367 at a screed surface temperature of at least 15°C and a relative humidity of 30 to max. 65%.
- | After installation of the flooring (completion), this climate must be maintained for one week (adhering and hardening time of adhesives and other material layers used).
- | After installation of MEISTER cork flooring, the maximum surface temperature of 29°C may not be exceeded.

Important note: The above points must be carried out according to the relevant rules and/or confirmed by specialists (architect, heating specialist etc.).

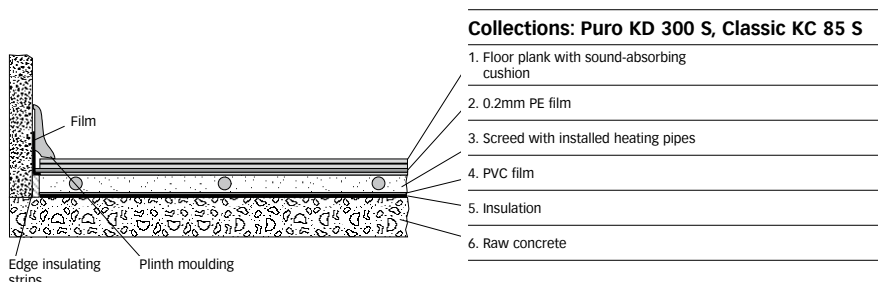

MEISTER linoleum flooring on warm water heated floor constructions

All MEISTER linoleum flooring is suitable for installation on hot-water underfloor heating.

Please follow the instructions below:

When installed with MEISTER PE film (0.2mm), MEISTER flooring from the Puro LID 300 S collection has a heat transmission resistance of 0.08m² K/W. Due to the natural warmth of the flooring, the heating can be switched off more often during moderately cold weather compared to heating under tiled floors. MEISTER flooring on hot-water underfloor heating reaches an even surface temperature all over.

The floors must not be covered with any coverings, e.g. carpets, runners, mats or any other overlays as this may cause an accumulation of heat. These types of flooring react with deformations and warping.

When laying on hot water underfloor heating in commercial areas, we recommend the installation of a fidbox® (measuring device from floorprotector).

Preparatory measures:

Any room heated over a large area requires planning and coordination of the heating system, the screed and the various coverings, taking into account the type of use, in order to ensure optimum and fault-free functioning over the long term. When these special floor constructions are installed, professional standards are correspondingly important. Supplies and processing steps must correspond with the latest technology, the available information sheets from the central association of the German construction trade and the assembly and installation guidelines of the relevant system suppliers and manufacturers.

Caution! In case of underfloor heating, the bottom profiles of the transition profiles etc. are fixed with mounting adhesive.

Screed – Checking moisture – Readiness for laying

After completion and a corresponding lying time, the screed can be heated. Complete drying out (readiness for laying) is an absolute prerequisite for the preparation and installation steps for MEISTER linoleum flooring and is therefore essential. The reason for this is that the moisture measurements to be carried out as part of subfloor checking cannot be reliably performed on heated constructions due to the risk of damage. This means that heated screed must be dried out by means of heating up and cooling down with a heating break before installation of any type of covering. To be ready for the installation of MEISTER flooring, the moisture content (according to DIN 4725, part 4 – measured with CM devices) of cement screed should be a maximum of 1.8 CM% and of anhydrite screed it should be a maximum of 0.3 CM%.

The moisture content limits also apply to fast-hardening cement and screed with screed additives – TKB technical briefing note 14.

Special measures

(heating up and cooling down)

The client must observe the following instructions and/or have them performed by the persons responsible:

- | The screed with underfloor heating must be heated up after its respective holding time in accordance with its specific data sheet.
- | During heating up, the initial temperature should be increased daily up to the full (maximum) heating power.
- | The pattern of the heating measure and the heating break must be carried out in accordance with the measure protocol.
- | The time plan indicates the minimum period of heating up – each additional day is of further benefit and provides extra security.
- | MEISTER linoleum floorings must be installed in accordance with DIN 18 356, 18 365 and 18 367 at a screed surface temperature of at least 15°C and a relative humidity of 30 to max. 65%.
- | After installation of the flooring (completion), this climate must be maintained for one week (adhering and hardening time of adhesives and other material layers used).
- | After installation of MEISTER linoleum flooring, the maximum surface temperature of 29°C may not be exceeded.

Important note: The above points must be carried out according to the relevant rules and/or confirmed by specialists (architect, heating specialist etc.).

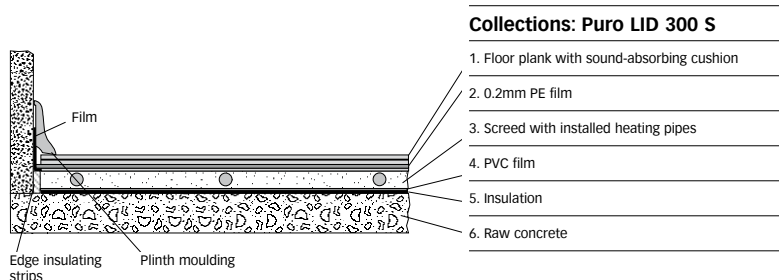

MEISTER design flooring on warm water heated floor constructions

The MEISTER design flooring is suitable for installation on hot-water underfloor heating.

Please follow the instructions below:

When installed with MEISTER PE film (0.2mm), MEISTER flooring from the DD 350 S collections have a heat transmission resistance of 0.10m² K/W. and those from the collections DD 85 S, DD 300 S and DD 75 S, a value of 0.05m² K/W. The DD 300, DD 75 and DD8 5 collection's heat transfer resistance is 0.05m² K/W when laid on MEISTER Silence 15 DB. Due to the natural warmth of the flooring, the heating can be switched off more often during moderately cold weather compared to heating under tiled floors. MEISTER flooring on underfloor heating reaches an even surface temperature all over. The floors must not be covered with any coverings, e.g. carpets, runners, mats or any other overlays as this may cause an accumulation of heat. These types of flooring react with deformations and warping. When laying on hot water underfloor heating in commercial areas, we recommend the installation of a fidbox® (measuring device from floorprotector).

Preparatory measures:

Any room heated over a large area requires planning and coordination of the heating system, the screed and the various coverings, taking into account the type of use, in order to ensure optimum and fault-free functioning over the long term. When these special floor constructions are installed, professional standards are correspondingly important. Supplies and processing steps must correspond with the latest technology, the available information sheets from the central association of the German construction trade and the assembly and installation guidelines of the relevant system suppliers and

manufacturers.

Caution!In case of underfloor heating, the bottom profiles of the transition profiles etc. are fixed with mounting adhesive.

Screed – Checking moisture – Readiness for laying

After completion and a corresponding lying time, the screed can be heated. Complete drying out (readiness for laying) is an absolute prerequisite for the preparation and installation steps for MEISTER design flooring and is therefore essential. The reason for this is that the moisture measurements to be carried out as part of subfloor checking cannot be reliably performed on heated constructions due to the risk of damage. This means that heated screed must be dried out by means of heating up and cooling down with a heating break before installation of any type of covering. To be ready for the installation of MEISTER flooring, the moisture content (according to DIN 4725, part 4 – measured with CM devices) of cement screed should be a maximum of 1.8 CM% and of anhydrite screed it should be a maximum of 0.3 CM%.

The moisture content limits also apply to fast-hardening cement and screed with screed additives – TKB technical briefing note 14.

Special measures

(heating up and cooling down)

The client must observe the following instructions and/or have them performed by the persons responsible:

- | The screed with underfloor heating must be heated up after its respective holding time in accordance with its specific data sheet.
- | During heating up, the initial temperature should be increased daily up to the full (maximum) heating power.
- | The pattern of the heating measure and the heating break must be carried out in accordance with the measure protocol.
- | The time plan indicates the minimum period of heating up – each additional day is of further benefit and provides extra security.
- | MEISTER design flooring must be installed in accordance with DIN 18 356, 18 365 and 18 367 at a screed surface temperature of at least 15°C and a relative humidity of 30 to max. 65%.
- | After installation of the flooring (completion), this climate must be maintained for one week (adhering and hardening time of adhesives and other material layers used).
- | After installation of MEISTER design flooring, the maximum surface temperature of 29°C may not be exceeded.

Important note: The above points must be carried out according to the relevant rules and/or confirmed by specialists (architect, heating specialist etc.).

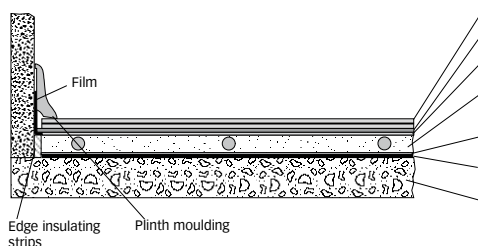

Collections: DD 300, DD 75, DC 75, DD 85	DD 300 S, DD 350 S, DD 75 S, DC 75 S, DD 85 S
1. Floor plank	Floor plank with sound-absorbing cushion
2. Silence 20 3. 0.2mm PE film	or Silence 15 DB or Silence 25 DB 0.2mm PE film
4. Screed with installed heating pipes	Screed with installed heating pipes
5. PVC film	PVC film
6. Insulation	Insulation
7. Raw concrete	Raw concrete

MEISTER Nadura flooring on warm water heated floor constructions

All MEISTER Nadura flooring is suitable for installation on hot-water underfloor heating.

Please follow the instructions below:

When installed with MEISTER-Silence 25 DB MEISTER flooring from the NB 400 and NQ 500 collection has a heat transmission resistance of 0.10m² K/W. Due to the natural warmth of the flooring, the heating can be switched off more often during moderately cold weather compared to heating under tiled floors. MEISTER flooring on hot-water underfloor heating reaches an even surface temperature all over.

The floors must not be covered with any coverings, e.g. carpets, runners, mats or any other overlays as this may cause an accumulation of heat. These types of flooring react with deformations and warping. When laying on hot water underfloor heating in commercial areas, we recommend the installation of a fidbox® (measuring device from floorprotector).

Preparatory measures:

Any room heated over a large area requires planning and coordination of the heating system, the screed and the various coverings, taking into account the type of use, in order to ensure optimum and fault-free functioning over the long term. When these special floor constructions are installed, professional standards are correspondingly important. Supplies and processing steps must correspond with the latest technology, the available information sheets from the central association of the German construction trade and the assembly and installation guidelines of the relevant system suppliers and manufacturers.

Caution! In case of underfloor heating, the bottom profiles of the transition profiles etc. are fixed with mounting adhesive.

Screed – Checking moisture – Readiness for laying

After completion and a corresponding lying time, the screed can be heated. Complete drying out (readiness for laying) is an absolute prerequisite for the preparation and installation steps for MEISTER Nadura flooring and is therefore essential. The reason for this is that the moisture measurements to be carried out as part of subfloor checking cannot be reliably performed on heated constructions due to the risk of damage. This means that heated screed must be dried out by means of heating up and cooling down with a heating break before installation of any type of covering. To be ready for the installation of MEISTER flooring, the moisture content (according to DIN 4725, part 4 – measured with CM devices) of cement screed should be a maximum of 1.8 CM% and of anhydrite screed it should be a maximum of 0.3 CM%.

The moisture content limits also apply to fast-hardening cement and screed with screed additives – TKB technical briefing note 14.

Special measures

(heating up and cooling down)

The client must observe the following instructions and/or have them performed by the persons responsible:

- | The screed with underfloor heating must be heated up after its respective holding time in accordance with its specific data sheet.
- | During heating up, the initial temperature should be increased daily up to the full (maximum) heating power.
- | The pattern of the heating measure and the heating break must be carried out in accordance with the measure protocol.
- | The time plan indicates the minimum period of heating up – each additional day is of further benefit and provides extra security.
- | MEISTER Nadura flooring must be installed in accordance with DIN 18 356, 18 365 and 18 367 at a screed surface temperature of at least 15°C and a relative humidity of 30 to max. 65%.
- | After installation of the flooring (completion), this climate must be maintained for one week (adhering and hardening time of adhesives and other material layers used).
- | After installation of MEISTER Nadura flooring, the maximum surface temperature of 29°C may not be exceeded.

Important note: The above points must be carried out according to the relevant rules and/or confirmed by specialists (architect, heating specialist etc.).

Structure of floating installation

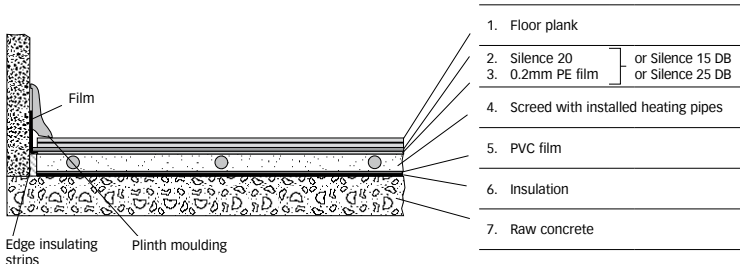

Structure of surface bonding

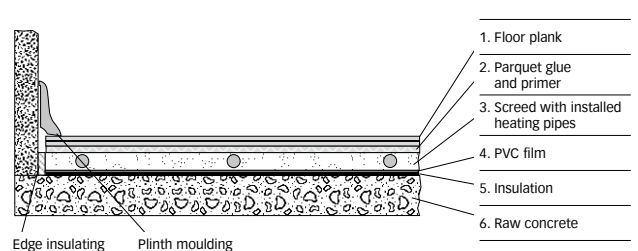

Note: Full surface bonding must be carried out by a professional.

MEISTER laminate flooring on warm water heated floor constructions

All MEISTER laminate flooring is suitable for installation on hot-water underfloor heating.

Preparatory measures:

Any room heated over a large area requires planning and coordination of the heating system, the screed and the various coverings, taking into account the type of use, in order to ensure optimum and fault-free functioning over the long term. When these special floor constructions are installed, professional standards are correspondingly important. Supplies and processing steps must correspond with the latest technology, the available information sheets from the central association of the German construction trade and the assembly and installation guidelines of the relevant system suppliers and manufacturers. The floors must not be covered with any coverings, e.g. carpets, runners, mats or any other overlays as this may cause an accumulation of heat. These types of flooring react with deformations and warping.

Caution! The bottom profiles of the transition rails etc. are fixed with installation adhesive for underfloor heating.

Screed – Checking moisture – Readiness for laying

After completion and a corresponding lying time, the screed can be heated. Complete drying out (readiness for laying) is an absolute prerequisite for the preparation and installation steps for MEISTER laminate flooring and is therefore essential. The reason for this is that the moisture measurements to be carried out as part of subfloor checking cannot be reliably performed on heated constructions due to the risk of damage. This means that heated screed must be dried out by means of heating up and cooling down with a heating break before installation of any type of covering. To be ready for the installation of MEISTER flooring, the moisture content (according to DIN 4725, part 4 – measured with CM devices) of cement screed should be a maximum of 1.8 CM% and of anhydrite screed it should be a maximum of 0.3 CM%.

The moisture content limits also apply to fast-hardening cement and screed with screed additives – TKB technical briefing note 14.

Special measures

(heating up and cooling down)

The client must observe the following instructions and/or have them performed by the persons responsible:

- | The screed with underfloor heating must be heated up after its respective holding time in accordance with its specific data sheet.
- | During heating up, the initial temperature should be increased daily up to the full (maximum) heating power.
- | The pattern of the heating measure and the heating break must be carried out in accordance with the measure protocol

- | The time plan indicates the minimum period of heating up – each additional day is of further benefit and provides extra security.
- | MEISTER laminate floorings must be installed in accordance with DIN 18 356, 18 365 and 18 367 at a screed surface temperature of at least 15°C and a relative humidity of 30 to max. 65%.
- | After installation of the flooring (completion), this climate must be maintained for one week (adhering and hardening time of adhesives and other material layers used).
- | After installation of MEISTER laminate flooring, the maximum surface temperature of 29°C may not be exceeded.

Important note: The above points must be carried out according to the relevant rules and/or confirmed by specialists (architect, heating specialist etc.).

Laminate flooring heat transmitting resistance MEISTER laminate flooring on insulating underlays

	Installation on MEISTER-Duo-Guard m ² K/W	Installation on MEISTER-Silence 25 DB m ² K/W
Laminate flooring Melango	–	0.09
Laminate flooring Micala	0.115	0.07
Laminate flooring Talamo	0.115	0.07
Laminate flooring Classic		
LB 85	0.115	0.07
LD 95	0.115	0.07
LD 75	0.115	0.07
LC 75	0.115	0.07
LC 55	0.104	–
LB 85	0.115	0.07

Laminate flooring with integrated sound-absorbing lining

	Installation on MEISTER-Duo-Guard m ² K/W	Installation with 0.2 mm MEISTER-PE film m ² K/W
Laminate flooring Melango	–	0.083
Laminate flooring Micala	–	0.075
Laminate flooring Talamo	–	0.075
Laminate flooring Classic		
LD 95 S	–	0.075
LD 75 S	–	0.075
LC 75 S	–	0.075
LC 55 S	–	0.069

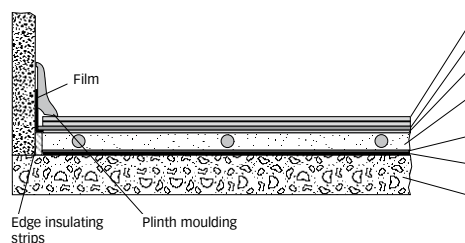

Collections:

Laminate flooring Melango, Micala, Talamo, Classic

	Laminate flooring Melango, Micala, Talamo, Classic
1. Floor plank	Floor plank with sound-absorbing cushion
2. Foam film 3. 0.2mm PE film	or Duo-Guard or Silence 15 DB or Silence 25 DB 0.2mm PE film
4. Screed with installed heating pipes	Screed with installed heating pipes
5. PVC film	PVC film
6. Insulation	Insulation
7. Raw concrete	Raw concrete

Full surface bonding with MEISTER Longlife parquet, Lindura wood flooring and Nadura

MEISTER Longlife parquet flooring, Lindura wood flooring and Nadura can also be installed with full surface bonding using an approved adhesive as an alternative to float-installation.

Please note that all installation instructions for Masterclac Plus connections, Quadroclic Plus connections and Uniclic connections must be followed carefully at all times as well as the general recommendations / Technical Commission on Construction Adhesives (TKB) technical briefing notes and preparatory measures explained in the installation instructions when installing flooring with full surface bonding.

MeisterWerke recommends a water-free, shear-resistant adhesive released by the adhesive manufacturer. If you require more information please contact the MeisterWerke or adhesive manufacturer's technical customer service.

Information on adhesives:

The recommendations for adhesives are based on extensive tests conducted by the manufacturers. Due to the variability of on-site conditions, it is not possible to establish warranty claims based on the information provided. We cannot assume liability for any losses incurred in using the adhesive system. For that reason, we recommend that you test the adhesive yourself thoroughly before installing flooring or contact the adhesive manufacturer's technical customer service.

Installation method:

With the floors mentioned lay each plank individually in the fresh adhesive bed. Then press them down well so that the backs of the planks are moistened as thoroughly as possible. To avoid hollow spots, extra weight can also be applied to the planks using a suitable material. Please note all of the adhesive manufacturer's instructions such as those on hardening and working time.

According to DIN 18 365 and 18356, the subsurface for flooring or parquet must always be smooth, dry, clean, free of cracks and release agents, and able to withstand lifting and pressing force.

CM moisture content with screed:

Cement screed: 2.0 CM-% (with underfloor heating: 1.8 CM-%)

Anhydrite screed: 0.5 CM-% (with underfloor heating: 0.3 CM-%)

(The moisture content limits also apply to fast-hardening cement and screed with screed additives – TKB technical briefing note 14.)

The contractor responsible for laying the flooring/parquet must ensure that subsurface material is inspected for technical suitability. This inspection must be in accordance with the recognised rules of the trade and current technology, and in compliance with the German Construction Contract Procedures (Vergabe- und Vertragsordnung für Bauleistungen – VOB). If the subsurface reveals deficiencies or there is a risk of damage occurring to the construction of the flooring, the contractor must report these concerns in writing, particularly in the following cases:

- | Serious unevenness
- | Cracks in the subsurface
- | Insufficiently dry subsurface
- | Insufficiently firm surface
- | Contaminated subsurfaces, e.g. oil, wax, lacquer, paint residues
- | Subsurface not being level with adjoining structures
- | Unsuitable subsurface temperature
- | Unsuitable room climate
- | No documentation on heating characteristics for heated flooring constructions
- | Required secure locking of expansion joints in the subsurface
- | No edging strip projection
- | No marking of measurement points for heated flooring constructions
- | No joint layout (if necessary)

Fidbox®

Humidity and fluctuations in temperature can influence how long a floor lasts and retains its value. We therefore recommend using a fidbox® (a measuring device from floorprotector), which can take long-term data recordings for temperature (°C) and relative humidity (%) in the immediate vicinity of the floor, which can be read using a reading device. If there should be a claim for damage, this can be clarified quickly using the results thus preventing any protracted research into the causes. You can obtain more information from MeisterWerke.

Care products

Overview of the use of the care products

	Cleaning after completion of construction work/day-to-day cleaning	Freshening care	Special cleaning
MEISTER-Longlife parquet and Lindura wood flooring			
naturally oiled	CC Wood Care for Oiled Floors MR: 1:200 Article no. 9061 87 070 A22	CC H ₂ Oil MR: undiluted Article no. 9061 87 160 A22	CC Deep Clean for hard floors MR: 1:1 to 1:3 Article no. 9061 87 040 A22
	In areas with heavy wear/ co mmercial areas: First cleaning CC Premium Care Oil for Wood Floors MR: undiluted Article no. 9061 87 080 A22	In areas with heavy wear/ co mmercial areas: CC Premium Care Oil for Wood Floors MR: undiluted Article no. 9061 87 080 A22	
lacquered matt lacquered	CC Wood and Cork Floor Cleaner MR: 1:200 Article no. 9061 87 012 A22	CC Wood and Cork Floor Polish mat MR: undiluted Article no. 9061 87 031 A22	CC Deep Clean for hard floors MR: undiluted Article no. 9061 87 040 A22
high-gloss lacquered	CC Wood and Cork Floor Cleaner MR: 1:200 Article no. 9061 87 012 A22		CC Deep Clean for hard floors MR: undiluted Article no. 9061 87 040 A22
MEISTER design flooring			
	1. Cleaning after completion of construction work: CC PU Cleaner MR: 1:10 Article no. 9061 87 150 A22 2. Day-to-day cleaning: CC PU Cleaner MR: 1:200 Article no. 9061 87 150 A22	CC Floor Mat MR: undiluted Article no. 9061 87 090 A22	CC Deep Clean for hard floors MR: undiluted Article no. 9061 87 040 A22
MEISTER cork flooring			
naturally oiled	CC Wood Care for Oiled Floors MR: 1:200 Article no. 9061 87 070 A22	CC H ₂ Oil MR: undiluted Article no. 9061 87 160 A22	CC Deep Clean for hard floors MR: 1:1 to 1:3 Article no. 9061 87 040 A22
lacquered matt lacquered	CC Wood and Cork Floor Cleaner MR: 1:200 Article no. 9061 87 012 A22	CC Wood and Cork Floor Polish mat MR: undiluted Article no. 9061 87 031 A22	CC Deep Clean for hard floors MR: 1:1 to 1:3 Article no. 9061 87 040 A22
MEISTER linoleum flooring			
	1. Cleaning after completion of construction work: CC PU Cleaner MR: 1:10 Article no. 9061 87 150 A22 2. Day-to-day cleaning: CC PU Cleaner MR: 1:200 Article no. 9061 87 150 A22	CC Floor Mat MR: undiluted Article no.: 9061 87 090 A22	CC Deep Clean for hard floors MR: undiluted Article no. 9061 87 040 A22
MEISTER Nadura flooring			
	CC Laminate Cleaner MV: 1:200 Article no. 9061 87 001 A22		CC Deep Clean for hard floors MR: undiluted Article no. 9061 87 040 A22
MEISTER laminate flooring			
	CC Laminate Cleaner MR: 1:200 Article no. 9061 87 001 A22		CC Elatex Stain Remover MR: undiluted Article no. 9061 87 110 A22

MR = mixing ratio

Care products

The quality does not stop with the installation.

You have bought a quality product "made in Germany". These cleaning and care instructions will provide you with all the information important to ensuring a long period of value preservation and a beautiful appearance of your flooring. With a bit of time and effort, you can contribute to ensuring that you are able to enjoy your new MEISTER flooring for a long time to come.

MEISTER products are based on selected materials, which are processed by experienced experts with state-of-the-art technology to create a quality product "made in Germany". The premium quality includes substantiated consultation and excellent service. For this reason, you will only find MEISTER products in selected specialist shops.

1. The right care

Your dream floor also needs the right care. MEISTER complements its product range with a high-quality series of care products from CC Dr. Schutz. Cleaners and care products, tailored for the floorings, ensure that your floor looks good in the long term. Even if you only need to run the vacuum round for day-to-day care (to remove loose dust), the surfaces should be cleaned and cared for regularly with CC Dr. Schutz care products to preserve the value of your floor.

When cleaning, please be aware that the floor must only ever be slightly moistened. In the ideal case, the film of water should be a thin mist, so that it dries out after about a minute. Some types of wood, such as beech or maple, are particularly sensitive to moisture.

You should not use any abrasive cleaners, even in case of more severe stains. Even for stubborn stains and dirt, the CC Elatex Stain Remover* will help. Scratches on the floor not only affect the overall appearance. They will also make the floor more prone to dirt and moisture. The CC Dr. Schutz care products are designed to ensure that the floor is considerably more resistant to signs of wear and tear in heavy wear areas. Your qualified specialist shops will also be able to provide you with more tips on how to care for your MEISTER floor in the best possible way.

2. Preservation of value precautionary measures

A room temperature of approx. 18–22°C and a relative air humidity of approx. 30–65 percent will contribute to your personal well-being and are the basis for a healthy room climate. With such a room climate, you will also help your MEISTER floor obtain the optimal conditions, as it reacts to its climatic surroundings like any other wooden material.

Low air humidity with a high temperature will lead to a contracting process in the wood, which dries the floor out. If you determine an air humidity which is considerably lower than 30 percent in the long term, we recommend the use of air humidifiers (vaporizers). This will prevent your MEISTER floor drying out excessively. As with all wooden products, very high air humidity will cause absorption of humidity, which can lead to the length and thickness increasing.

The introduction of dirt onto the floor:

Most dirt is brought into your home from the outside and transferred onto the flooring. For this reason, we recommend installing a sufficiently large entrance covering (e.g. a doormat) in the entrance. Please consider that dirt, such as sand or small stones, will act like sandpaper on all floorings and can lead to unsightly scratches. To protect the wood from scratches, you should also fit chair and furniture feet with felt sliders; office chairs, mobile containers, etc., on castors must be equipped with soft, standard running surfaces. We recommend protecting the floor in these heavy wear areas with appropriate floor protection mats (e.g. polycarbonate mats).

Care products

3. Cleaning after completion of construction work

Newly laid MEISTER floors must be cleaned after completion of construction work and before first use in order to completely remove any dirt or glue residue which has arisen during the course of the installation.

You should clean **MEISTER laminate flooring** after completion of construction work with CC Laminate Cleaner*, diluted with water in a ratio of 1:200.

You should clean **MEISTER Nadura flooring** after completion of construction work with CC Laminate Cleaner*, diluted with water in a ratio of 1:200.

The cleaning after completion of construction work of **lacquered, matt lacquered and high gloss lacquered MEISTER Longlife parquet and Lindura wood flooring** should be carried out with CC Wood and Cork Floor Cleaner*, diluted with water in a ratio of 1:200.

The cleaning after completion of construction work on **naturally oiled MEISTER Longlife parquet and MEISTER Lindura wood flooring** should be carried out with CC Wood Care for Oiled Floors*, diluted with water in a ratio of 1:200. The flooring has been treated ready for residential use. To achieve further surface protection (so-called sacrificial layer), you can then apply undiluted H₂Oil in a thin and even layer to the flooring using a lint-free mop. Treatment with CC-Premium Care Oil in accordance with manufacturer's instructions will result in even better and longer-lasting surface protection.

For commercial areas and areas which are particularly highly frequented, subsequent treatment with CC-Premium Care Oil is necessary. Apply the care oil in accordance with the manufacturer's instructions. After drying (at least 12 hours), the floor can be used again and can be cleaned using a thin mist of water again after allowing it to completely harden for 7-10 days.

The cleaning after completion of construction work on **lacquered and matt lacquered MEISTER cork flooring** should be carried out with CC Wood and Cork Floor Cleaner*, diluted with water in a ratio of 1:200.

The cleaning after completion of construction work on **naturally oiled MEISTER cork flooring** should be carried out with CC Wood Care for Oiled Floors*, diluted with water in a ratio of 1:200.

You should clean **MEISTER linoleum flooring** after completion of construction work with CC PU Cleaner*, diluted with water in a ratio of 1:10. Clean the floor using a well wrung out mop and then neutralise with clear water.

You should clean **MEISTER design flooring and MEISTER design flooring** after completion of construction work with CC PU Cleaner*, diluted with water in a ratio of 1:10. Clean the floor using a well wrung out mop and then neutralise with clear water.

The floor is washed with a mist of water using the relevant cleaning solution and a **non-lint** mop.

** Water-based care products (e.g. polymer dispersions) or CC Elatex Stain Remover can penetrate the seams of the planks in the case of improper adhesion or incomplete jointing, leading to swelling of the carrier material.*

4. Day-to-day cleaning

MEISTER laminate flooring

To remove daily dirt, vacuuming or sweeping is sufficient. For conventional mopping, CC Laminate Cleaner*, diluted with water in a ratio of 1:200, can be used. The floor should be wiped with a thin mist of water using a non-lint cloth, which has been dipped in this solution and wrung out well. Remove stains, smears and other bonded dirt with CC Elatex Stain Remover* or undiluted CC Laminate Cleaner* and a non-scratch, white pad. Then, wipe with a thin mist of water, until the dirt and cleaning agent residue is completely removed.

MEISTER Nadura flooring

To remove daily dirt, vacuuming or sweeping is sufficient. For conventional mopping, CC Laminate Cleaner*, diluted with water in a ratio of 1:200, can be used. The floor should be wiped with a thin mist of water using a non-lint cloth, which has been dipped in this solution and wrung out well. If necessary, use a scrubbing brush.

To remove stubborn stains dilute the Wood Floor Deep Clean with water in a ratio of 1:1 to 1:3 and spray the floor (using a hand spray or similar). Leave it to take effect for 5 minutes maximum, depending on the stubbornness of the stains. Then scrub the floor using a scrubbing brush. Remove the loosened dirt using a well pressed cloth and neutralise the floor using clean, if possible warm water until any residue dirt or cleaning products have been completely removed.

Remove stains and heel marks with CC Elatex Stain Remover* (universal stain remover) or undiluted CC Laminate Cleaner* or CC Wood Floor Deep Clean* and a non-scratch, white pad. Then, wipe with a thin mist of water, until the dirt and cleaning agent residue is completely removed.

In **commercial** properties cleaning should always be possible using a cleaning machine or spray cleaning process with a disk buffing machine. For this, dilute CC Wood Floor Deep Clean* with water in a ratio of 1:1. Please contact our technical customer services in case of application.

Care products

Lacquered and matt lacquered MEISTER Longlife parquet and Lindura wood flooring

To remove daily dirt, vacuuming or sweeping is sufficient. Depending on the frequency and level of dirt, dilute CC Wood and Cork Floor Cleaner* with water in a ratio of 1:200.

The floor should be wiped with a thin mist of water using a non-lint cloth, which has been dipped in this solution and wrung out well.

Remove fatty stains and other bonded dirt with undiluted CC Wood and Cork Floor Cleaner* and a non-scratch, white pad. Then, wipe with a thin mist of water, until the dirt and cleaning agent residue is completely removed. Problem stains can be removed with CC Wood Floor Deep Clean.

We recommend refreshing the floor with CC Wood and Cork Floor Polish mat to preserve its quality and at the first sign of wear. In areas subject to heavier levels of dirt or to build up resistance to wear, first carry out a deep clean using CC Wood Floor Deep Clean non-diluted with a green pad. After the floor as dried completely, apply CC-H₂Oil* undiluted very thinly and evenly with a non-lint mop. Leave the floor to dry for at least 12 hours before use.

With the afore-mentioned deep clean use dthe CC Wood Floor Deep Clean* non-diluted. Distribute the cleaning solution over the floor in sections using a cloth and then immediately remove any residue of the care product by scrubbing. Make sure that no puddles form. For larger surfaces, use a disk buffing machine with a green pad. Immediately absorb any dirty water completely with absorbent, dry cloths. Then wipe with a thin mist of clean water using a cloth. If possible carry out the cleaning in pairs so that one person removes the dirt and the other person immediately absorbs any dirty water.

Note: High-gloss lacquered MEISTER Longlife parquet

At first signs of wear refreshing the floor with corresponding care products is possible. These products however influence the high-gloss look of the parquet floor.

Naturally oiled MEISTER parquet flooring and naturally oiled MEISTER Lindura wood flooring

To remove daily dirt, vacuuming or sweeping is sufficient. For regular cleaning and care use CC Wood Care for Oiled Floors* diluted with water in a ratio of 1:200. The floor should be wiped with a thin mist of water using a cloth, which has been dipped in this solution and wrung out well. The flooring is cleaned and cared for in one step. We recommend refreshing the floor with CC-H₂Oil* to preserve its quality and at the first sign of wear. With normal levels of dirt clean the floor first using CC Wood Care for Oiled Floors diluted with water in a ratio of 1:200 and a green pad. After the floor has dried completely, apply CC-H₂Oil* undiluted very thinly and evenly with a non-lint mop. Leave the floor to dry for at least 12 hours before use.

In cases of heavy soiling or care product build-up, carry out intensive cleaning first using CC intensive cleaner* diluted to the ratio 1:1 to 1:3 with water and a green pad. Distribute the cleaning solution over the floor in sections using a cloth and then immediately remove any residue of the care product by scrubbing. Make sure that no puddles form. For larger surfaces, use a disk buffing machine with a green pad. Immediately absorb any dirty water completely with absorbent, dry cloths. Then wipe with a thin mist of clean water using a cloth. If possible carry out the cleaning in pairs so that one person removes the dirt and the other person immediately absorbs any dirty water. Subsequently, the flooring must always be re-oiled using CC-Premium Care Oil in accordance with the manufacturer's instructions.

After drying (at least 12 hours), the floor can be used again and can be cleaned damp again after allowing it to completely harden for 7 days.

Where naturally oiled MEISTER Longlife parquet and naturally oiled Lindura wooden flooring are laid in areas subject to heavier wear or commercial areas,

we always recommend refreshing/re-oiling the entire surface with CC Premium Care Oil in accordance with manufacturer's instructions if e.g. the surface becomes unsightly (extreme dirt, greying etc.). First, the floor must be cleaned thoroughly with CC Wood Floor Deep Clean (diluted with water at a ratio of 1:1 to 1:3).

After drying (at least 12 hours), the floor can be used again and can be cleaned using a thin mist of water again after allowing it to completely harden for 7 days.

Osmo products can be used to clean and care for naturally oiled MEISTER Longlife parquet flooring and Lindura wood flooring.

For regular cleaning and care, we recommend Osmo Wisch-Fix, diluted with water. The floor should be washed with a thin mist of water and mop. Then wipe dry. With regular use, the surface becomes resistant to new occurrences of dirt and signs of wear-and-tear. To remove particularly stubborn stains and for occasional, intensive refreshing or maintenance, we recommend Osmo Wax Care and Cleaning Agent. First, the floor must be cleaned thoroughly with Osmo-Wisch-Fix. Immediately absorb any dirty water completely with an absorbent, dry mop. Apply Osmo Wax Care and Cleaning Agent thinly and evenly with a non-lint cloth. For larger surfaces, use a disk buffing machine with a white pad. Remove any surplus immediately with a dry cloth. After drying, the surface can be polished if required. For heavier signs of wear-and-tear and for renovations, the floor should be treated afterwards with Osmo Hard Wax Oil 3062 matt.

Care products

Lacquered and matt lacquered MEISTER cork flooring

Daily maintenance cleaning should be dry if possible (e.g. vacuuming/sweeping). Depending on the frequency and level of dirt, dilute CC Wood and Cork Floor Cleaner* with water in a ratio of 1:200. The floor should be wiped with a thin mist of water using a cloth, which has been dipped in this solution and wrung out well. Remove fatty stains and other bonded dirt with undiluted CC Wood and Cork Floor Cleaner* and a non-scratch, white pad. Then, wipe with a thin mist of water, until the dirt and cleaning agent residue is completely removed. In areas subject to heavier levels of dirt, add CC Wood and Cork Floor Polish mat* for intensive care and apply undiluted, thinly and evenly with a lint-free mop onto the thoroughly cleaned floor (with CC Wood Floor Deep Clean* for Wood and Cork Flooring undiluted).

MEISTER linoleum flooring

Loose dust and dirt is removed by vacuuming or sweeping.

Depending on the frequency and degree of dirt, the removal of bonded dirt should be carried out with CC PU Cleaner*, which is diluted with water at a ratio of 1:200. The floor should be wiped with a thin mist of water using a mop, which has been dipped in this solution and wrung out well. Remove stubborn stains and heel marks with undiluted CC PU Cleaner* and a cloth or non-scratch, white pad. Then wipe the floor with clear water. A thorough clean of the floor is required to remove particularly stubborn dirt and residues and to prepare the floor for treatment with a care product in case of visible signs of wear. For this evenly spray CC Deep Clean* undiluted on the floor and after allowing it to take effect for a short while (max. 5 minutes) scrub with a green pad or scrubbing brush. Wipe away loosened dirt using a cloth and wipe over again using clear water until all dirt and cleaner residue has been completely removed.

Note: If the flooring is not to receive a care treatment afterwards only use scrubbing brushes instead of green pads.

If there are signs of wear on the surface after long or intensive use, this can be refreshed with intensive maintenance after thoroughly cleaning the floor with (CC Deep Clean)*. To do this, apply CC Floor Mat* undiluted, thinly and evenly in a lengthwise direction with a lint-free mop rinsed in clear water and wrung out well. When the protective film can be walked on (after 45 minutes), apply a second coating in the crossways direction. Use: 750ml for approx. 25–35m² per application. If the protective film is worn away over the course of time, this can be refreshed with intensive maintenance after thoroughly cleaning the floor with CC Deep Clean*.

MEISTER design flooring

Loose dust and dirt is removed by vacuuming or sweeping. Depending on the frequency and degree of dirt, the removal of bonded dirt should be carried out with CC PU Cleaner*, which is diluted with water at a ratio of 1:200. The floor should be wiped with a thin mist of water using a mop, which has been dipped in this solution and wrung out well. Remove stubborn stains and heel marks with undiluted CC PU Cleaner* and a cloth or non-scratch, white pad. Then wipe the floor with clear water. A thorough clean of the floor is required to remove particularly stubborn dirt and residues and to prepare the floor for treatment with a care product in case of visible signs of wear. For this evenly spray CC Deep Clean* undiluted on the floor and after allowing it to take effect for a short while (max. 5 minutes) scrub with a green pad or scrubbing brush. Wipe away loosened dirt using a cloth and wipe over again using clear water until all dirt and cleaner residue has been completely removed.

Note: If the flooring is not to receive a care treatment afterwards only use scrubbing brushes instead of green pads.

If there are signs of wear on the surface after long or intensive use, this can be refreshed with intensive maintenance after thoroughly cleaning the floor with (CC Deep Clean)*. To do this, apply CC Floor Mat* undiluted, thinly and evenly in a lengthwise direction with a lint-free mop rinsed in clear water and wrung out well. When the protective film can be walked on (after 45 minutes), apply a second coating in the crossways direction. Use: 750ml for approx. 25–35m² per application. If the protective film is worn away over the course of time, this can be refreshed with intensive maintenance after thoroughly cleaning the floor with CC Deep Clean*.

In **commercial** properties cleaning should always be possible using a cleaning machine or spray cleaning process with a disk buffing machine as well as separate value conservation measures. Please contact our technical customer services in case of application.

Care products

5. General information on cleaning and care

Never leave MEISTER flooring moist or wet over a long period of time. When cleaning, always try to use a dry method if possible (using a mop, hair broom, vacuum cleaner), or only wipe with a thin mist of water (with wrung out cloths) and do not leave any "puddles" on the floor. Steam cleaners are not suitable for the flooring. Do not use any cream cleaners or scouring powders as these agents can attack the surface of the floor. Please only use suitable cleaners. Problem stains on laminate and Nadura floors as well as lacquered parquet and veneer flooring can be removed with CC Elatex Stain Remover (universal stain remover).

Please be aware that you may increase the gloss level on the laminate/ Nadura surface by removing the stain with increased pressure with a white pad. For this reason, try this out in an inconspicuous place or left-over plank first.

** Water-based care products (e.g. polymer dispersions) or CC Elatex Stain Remover (universal stain remover) can penetrate the seams of the planks in the case of improper adhesion or incomplete jointing, leading to swelling of the carrier material.*

Longlife warranty on MeisterWerke parquet

I. Warranty cover: MeisterWerke Schulte GmbH, Johannes-Schulte-Allee 5, 59602 Rütten-Meiste, provides a warranty, over and beyond statutory rights under § 437 of the German Civil Code (replacement, cancellation of contract, reduction of purchase price and compensation), under the following warranty conditions. With the triple-layer parquet coating (precious wood wear layer, middle layer and backing) the parquet's special durability is achieved by using a special middle layer made from high density fibre board (HDF). Therefore, MeisterWerke provides a warranty for the triple-layer product structure's strength with regards to the bonding of individual layers, provided the product is used for the purpose which it is intended in living areas. The warranty does not cover any damage caused by incorrect treatment and use. In particular, any load or wear on the flooring that is not the purpose for which the flooring was intended, mechanical damage caused by furniture, pets etc. such as dents and scratches, for example. Visual damage such as joints, changes in colour due to exposure to light and the deformation of individual planks caused by seasonal, room climate conditions are also not covered. Damage as a result of insect infestation, improper care, cleaning or maintenance of the surface and surface coating, specifically chemical damage or damage caused by the penetration of moisture is also not included. The warranty applies exclusively to first choice products and use in private living areas subject to normal wear, with the exception of humid rooms, such as bathrooms or saunas. The warranty only applies to products that were purchased and fitted within the European Union.

II. Warranty period: The warranty period for MEISTER parquet flooring is 35 years from the date of purchase.

III. Warranty conditions: The flooring must have been fitted in accordance with the installation instructions enclosed in every third product package, in the permitted areas of use named within the instructions. In particular, information in the installation instructions about checking the humidity of subsurfaces and the installation on underfloor heating must be observed. The material must be checked for any material faults or damage before being fitted. The floor must also be maintained and cleaned according to the care instructions enclosed with the product. If these installation or care instructions are missing and/or incomplete, the claimant is obliged to request this information from their specialist retailer or directly from MeisterWerke before fitting the flooring. In addition, it should be noted that the surface coating is a protective layer for the wooden wear layer underneath it and is subject to normal wear. The wear of this surface coating is therefore not covered by the warranty. If signs of wear appear, the surface must be renewed in good time, properly to the required extent by a specialist company. The warranty therefore does not extend to damage that results from improper installation, cleaning or care, as well as the delayed improper repair of the surface coating.

IV. Reporting a warranty claim: Any complaint must be made in writing, enclosing the original invoice from the specialist retailer, which serves as a certificate of warranty. If it is not possible to present the original retailer's invoice, any claim under the warranty is excluded. Once the claim is received by MeisterWerke, it must notify the customer within four weeks whether a warranty claim has been acknowledged. If no notification is given within this period, the warranty claim is deemed to have been rejected. During this period, MeisterWerke or a third party employed by them must be granted access to the product that is the subject of the complaint on site in order to investigate the claim.

V. Scope of the warranty: When a warranty claim is acknowledged, MeisterWerke will at their discretion repair the faulty floor element or alternatively provide replacement material of the same quality, if at all possible from the same range, for the entire room in which the problem has occurred. The customer can collect the replacement material free of charge from the original sales outlet stated in the original invoice, excluding any further claims over and beyond this, including but not limited to compensation claims for the removal or fitting of the flooring or for consequential damage that has occurred other than in the product supplied itself.

VI. Limitation of warranty: The warranty period is not extended by a warranty claim. Claims under the warranty expire six months from the date of MeisterWerke's receipt of the customer's written complaint (see IV.), but no earlier than the expiry of the warranty period.

Warranty on MeisterWerke Lindura wood flooring

I. Warranty cover: MeisterWerke Schulte GmbH, Johannes-Schulte-Allee 5, 59602 Rütten-Meiste, provides a warranty, over and beyond statutory rights under § 437 of the German Civil Code (replacement, cancellation of contract, reduction of purchase price and compensation), under the following warranty conditions. MeisterWerke warrants the durability of the multilayer product structure relating to pressing and fusing the single layers with one another. The warranty does not cover any damage caused by incorrect treatment and use. In particular, any load or wear on the flooring that is not the purpose for which the flooring was intended, mechanical damage caused by furniture, pets etc. such as dents and scratches, for example. Visual damage such as joints, changes in colour due to exposure to light and the deformation of individual planks caused by seasonal, room climate conditions are also not covered. Damage as a result of insect infestation, improper care, cleaning or maintenance of the surface and surface coating, specifically chemical damage or damage caused by the penetration of moisture is also not included. The warranty applies exclusively to first choice products and use in private living areas subject to normal wear up to heavy-wear areas, with the exception of humid rooms, such as bathrooms or saunas. The warranty only applies to products that were purchased and fitted within the European Union.

II. Warranty period: The warranty period is in accordance with the warranty time stated for each individual product and for the concrete type of use described, after the appropriate date of purchase respectively.

III. Warranty conditions: The flooring must have been fitted in accordance with the installation instructions enclosed in every third product package, in the permitted areas of use named within the instructions. In particular, information in the installation instructions about checking the humidity of subsurfaces and the installation on underfloor heating must be observed. The material must be checked for any material faults or damage before being fitted. The floor must also be maintained and cleaned according to the care instructions enclosed with the product. If these installation or care instructions are missing and/or incomplete, the claimant is obliged to request this information from their specialist retailer or directly from MeisterWerke before fitting the flooring. In addition, it should be noted that the surface coating is a protective layer for the wooden wear layer underneath it and is subject to normal wear. The wear of this surface coating is therefore not covered by the warranty. If signs of wear appear, the surface must be renewed in good time, properly to the required extent by a specialist company. The warranty therefore does not extend to damage that results from improper installation, cleaning or care, as well as the delayed improper repair of the surface coating.

IV. Reporting a warranty claim: Any complaint must be made in writing, enclosing the original invoice from the specialist retailer, which serves as a certificate of warranty. If it is not possible to present the original retailer's invoice, any claim under the warranty is excluded. Once the claim is received by MeisterWerke, it must notify the customer within four weeks whether a warranty claim

has been acknowledged. If no notification is given within this period, the warranty claim is deemed to have been rejected. During this period, MeisterWerke or a third party employed by them must be granted access to the product that is the subject of the complaint on site in order to investigate the claim.

V. Scope of the warranty: When a warranty claim is acknowledged, MeisterWerke will at their discretion repair the faulty floor element or alternatively provide replacement material of the same quality, if at all possible from the same range, for the entire room in which the problem has occurred. The customer can collect the replacement material free of charge from the original sales outlet stated in the original invoice, excluding any further claims over and beyond this, including but not limited to compensation claims for the removal or fitting of the flooring or for consequential damage that has occurred other than in the product supplied itself.

VI. Limitation of warranty: The warranty period is not extended by a warranty claim. Claims under the warranty expire six months from the date of MeisterWerke's receipt of the customer's written complaint (see IV.), but no earlier than the expiry of the warranty period.

Warranty on MeisterWerke cork and linoleum flooring

I. Warranty cover: MeisterWerke Schulte GmbH, Johannes-Schulte-Allee 5, 59602 Rütten-Meiste, provides a warranty, over and beyond statutory rights under § 437 of the German Civil Code (replacement, cancellation of contract, reduction of purchase price and compensation) under the following warranty conditions. MeisterWerke provides a warranty for the correctness of the product structure's triple-layered bonding, provided the product is used for the purpose which it is intended in living areas. The warranty does not cover any damage caused by incorrect treatment and use. In particular, any load or wear on the flooring that is not the purpose for which the flooring was intended, mechanical damage caused by furniture, pets etc. such as dents and scratches, for example. Visual damage such as joints, changes in colour due to exposure to light and the deformation of individual planks caused by seasonal, room climate conditions are also not covered. Damage as a result of insect infestation, improper care, cleaning or maintenance of the surface and surface coating, specifically chemical damage or damage caused by the penetration of moisture is also not included. The warranty applies exclusively to first choice products and use in private living areas subject to normal wear, with the exception of humid rooms, such as bathrooms or saunas. The warranty only applies to products that were purchased and fitted within the European Union.

II. Warranty period: The warranty period is in accordance with the warranty time stated for each individual product and for the concrete type of use described, after the appropriate date of purchase respectively.

III. Warranty conditions: The flooring must have been fitted in accordance with the installation instructions enclosed in every third product package, in the permitted areas of use named within the instructions. In particular, information in the installation instructions about checking the humidity of subsurfaces and the installation on underfloor heating must be observed. The material must be checked for any material faults or damage before being fitted. The floor must also be maintained and cleaned according to the care instructions enclosed with the product. If these installation or care instructions are missing and/or incomplete, the claimant is obliged to request this information from the specialist retailer or directly from MeisterWerke before fitting the flooring. In addition, it should be noted that the surface coating is a protective layer for the wooden cork or linoleum layer underneath it and is subject to normal wear. The wear of this surface coating is therefore not covered by the warranty. If signs of wear appear, the surface must be renewed in good time, properly to the required extent by a specialist company. The warranty therefore does not extend to damage that results from improper installation, cleaning or care, as well as the delayed improper repair of the surface coating.

IV. Reporting a warranty claim: Any complaint must be made in writing, enclosing the original invoice from the specialist retailer, which serves as a certificate of warranty. If it is not possible to present the original retailer's invoice, any claim under the warranty is excluded. Once the claim is received by MeisterWerke, it must notify

the customer within four weeks whether a warranty claim has been acknowledged. If no notification is given within this period, the warranty claim is deemed to have been rejected. During this period, MeisterWerke or a third party employed by them must be granted access to the product that is the subject of the complaint on site in order to investigate the claim.

V. Scope of the warranty: When a warranty claim is acknowledged, MeisterWerke will at their discretion repair the faulty floor element or alternatively provide replacement material of the same quality, if at all possible from the same range, for the entire room in which the problem has occurred. The customer can collect the replacement material free of charge from the original sales outlet stated in the original invoice, excluding any further claims over and beyond this, including but not limited to compensation claims for the removal or fitting of the flooring or for consequential damage that has occurred other than in the product supplied itself.

VI. Limitation of warranty: The warranty period is not extended by a warranty claim. Claims under the warranty expire six months from the date of MeisterWerke's receipt of the customer's written complaint (see IV.), but no earlier than the expiry of the warranty period.

Warranty of wear resistance for MeisterWerke design, Nadura and laminate flooring

I. Warranty cover: MeisterWerke Schulte GmbH, Johannes-Schulte-Allee 5, 59602 Rütten-Meiste, provides a warranty, over and beyond statutory rights under § 437 of the German Civil Code (replacement, cancellation of contract, reduction of purchase price and compensation) that the decorative/veneer layer on the purchased product will not wear away within the warranty period provided the product is used properly for the purpose intended, according to the following warranty conditions. Any spot on which the decorative/veneer layer has been removed down to the substrate material over an area of at least 1cm² is regarded as having worn away, though signs of wear on the edge area of an individual floor element are excluded from this warranty. Any load on the flooring that is not the purpose for which the flooring was intended, mechanical damage and failure to comply with the MeisterWerke care instructions for the respective flooring exclude any claim under the warranty. The warranty applies exclusively to first choice products and use in private living areas or commercial areas depending on the wear class specified, with the exception of humid rooms, such as bathrooms or saunas. The warranty only applies to products that were purchased and fitted within the European Union.

II. Warranty period: The warranty period is in accordance with the warranty time stated for each individual product and for the concrete type of use described, after the appropriate date of purchase respectively.

III. Warranty conditions: The flooring must have been fitted in accordance with the installation instructions enclosed in every

third product package, in the permitted areas of use named within the instructions. In particular, information in the installation instructions about checking the humidity of subsurfaces and the installation on underfloor heating must be observed. The material must be checked for any material faults or damage before being fitted. The floor must also be maintained and cleaned according to the care instructions enclosed with the product. If these installation or care instructions are missing and/or incomplete, the claimant is obliged to request this information from their specialist retailer or directly from MeisterWerke before fitting the flooring.

IV. Reporting a warranty claim: Any complaint must be made in writing, enclosing the original invoice from the specialist retailer, which serves as a certificate of warranty. If it is not possible to present the original retailer's invoice, any claim under the warranty is excluded. Once the claim is received by MeisterWerke, it must notify the customer within four weeks whether a warranty claim has been acknowledged. If no notification is given within this period, the warranty claim is deemed to have been rejected. During this period, MeisterWerke or a third party employed by them must be granted access to the product that is the subject of the complaint on site in order to investigate the claim.

V. Scope of the warranty: When a warranty claim is acknowledged, MeisterWerke will at their discretion repair the faulty floor element or alternatively provide replacement material of the same quality, if at all possible from the same range, for the entire room in which

the problem has occurred. The customer can collect the replacement material free of charge from the original sales outlet stated in the original invoice, excluding any further claims over and beyond this, including but not limited to compensation claims for the removal or fitting of the flooring or for consequential damage that has occurred other than in the product supplied itself.

VI. Limitation of warranty: The warranty period is not extended by a warranty claim. Claims under the warranty expire six months from the date of MeisterWerke's receipt of the customer's written complaint (see IV.), but no earlier than the expiry of the warranty period.

GB

© 2017 by MeisterWerke Schulte GmbH
For reasons of printing technology, colours and structures may vary from the
reproductions shown here. No responsibility is assumed for errors.

MEISTER – a brand of MeisterWerke Schulte GmbH
Johannes-Schulte-Allee 5 | 59602 Rùthen-Meiste | GERMANY
Phone: +49 2952 816-0 | Fax +49 2952 816-66 | www.meister.com